



CE EMC Test Report

Issued date: Dec. 06, 2024

Project No.: 24Q101106

Product : Rugged Embedded System

Model : ABP-4000

Series Model : ABP-4000 Series, ABP-4XXXXXXXXXX ("X" can be 0-9, A-Z or blank)

Applicant : Vecow Co., Ltd

Address : 3F, No. 10, Jiankang Rd., Zhonghe Dist., New Taipei City 23586, Taiwan

Report No: WD-EE-R-240374-A0

According to

- | | |
|--------------------------------------|-----------------------------------|
| EN 55032: 2015 + A11: 2020, Class A | IEC 61000-4-2: 2008 |
| BS EN 55032: 2015 + A11: 2020 | IEC 61000-4-3: 2020 |
| CISPR 32: 2015 + COR1: 2016 | IEC 61000-4-4: 2012 |
| EN 55032: 2015 + A1: 2020, Class A | IEC 61000-4-5: 2014 + A1: 2017 |
| BS EN 55032: 2015 + A1: 2020 | IEC 61000-4-6: 2023 |
| CISPR 32: 2015 + A1: 2019 | IEC 61000-4-8: 2009 |
| EN 61000-3-2: 2014 | IEC 61000-4-11: 2020 + COR2: 2022 |
| EN IEC 61000-3-2: 2019 + A1: 2021 | EN 61000-4-2: 2009 |
| EN 61000-3-3: 2013 + A2: 2021 | EN IEC 61000-4-3: 2020 |
| BS EN 61000-3-2: 2014 | EN 61000-4-4: 2012 |
| BS EN IEC 61000-3-2: 2019 + A1: 2021 | EN 61000-4-5: 2014 + A1: 2017 |
| BS EN 61000-3-3: 2013 + A2: 2021 | EN IEC 61000-4-6: 2023 |
| EN 55035: 2017 + A11: 2020 | EN 61000-4-8: 2010 |
| BS EN 55035: 2017 + A11: 2020 | EN IEC 61000-4-11: 2020 |

Authorized Signatory :  / Ken Huang



Wendell Industrial Co., Ltd
Wendell EMC & RF Laboratory

Add: 5F-1, No. 188, Baoqiao Road, Xindian District, New Taipei City 23145, Taiwan R.O.C.



Table of Contents

1	Certification	7
1.1	Summary of Result.....	8
2	Laboratory Information.....	9
2.1	Measurement / Test Facility	9
2.2	Measurement Uncertainty	10
2.2.1	Conducted Emission Measurement	10
2.2.2	Conducted Emission at Telecommunication Port Measurement	10
2.2.3	Radiated Emission Measurement.....	10
3	General Information.....	11
3.1	Description of Equipment Under Test	11
3.2	Description of Measurement / Test Modes	12
3.3	Description of Operating Condition	12
3.4	Description of Associated Equipment.....	13
3.5	Configuration of Equipment Under Test.....	14
4	Emission Measurement	15
4.1	Conducted Emission Measurement	15
4.1.1	Limit of Conducted Emission Measurement	15
4.1.2	Measurement Instrument	16
4.1.3	Measurement Procedure	17
4.1.4	Deviation from Standard.....	17
4.1.5	Measurement Configuration	18
4.1.6	Measurement Result	19
4.1.7	Photographs of Measurement Configuration	23
4.2	Conducted Emission at Telecommunication Port Measurement	24
4.2.1	Limit of Conducted Emission at Telecommunication Port Measurement	24
4.2.2	Measurement Instrument	26
4.2.3	Measurement Procedure	27
4.2.4	Deviation from Standard.....	27
4.2.5	Measurement Configuration	28
4.2.6	Measurement Result	29
4.2.7	Photographs of Measurement Configuration	32
4.3	Radiated Emission Measurement	33
4.3.1	Limit of Radiated Emission Measurement	33
4.3.2	Measurement Instrument	35
4.3.3	Measurement Procedure	36
4.3.4	Deviation from Standard.....	36
4.3.5	Measurement Configuration	37
4.3.6	Measurement Result	40
4.3.7	Photographs of Measurement Configuration	44
4.4	Harmonic Current Measurement	46
4.4.1	Limit of Harmonic Current Measurement	46
4.4.2	Measurement Instrument	46
4.4.3	Measurement Procedure	47
4.4.4	Deviation from Standard.....	48
4.4.5	Measurement Configuration	48
4.4.6	Measurement Result	49

4.4.7	Photographs of Measurement Configuration	50
4.5	Voltage Fluctuations and Flicker Measurement	51
4.5.1	Limit for Voltage Functions and Flicker Measurement	51
4.5.2	Measurement Instrument	51
4.5.3	Measurement Procedure	51
4.5.4	Deviation from Standard.....	51
4.5.5	Measurement Configuration	52
4.5.6	Measurement Result	53
4.5.7	Photographs of Measurement Configuration	54
5	Immunity Test	55
5.1	Standard Description	55
5.2	Performance Criteria	56
5.3	Electrostatic Discharge Immunity Test	57
5.3.1	Test Specification.....	57
5.3.2	Test Instrument	57
5.3.3	Test Procedure.....	58
5.3.4	Deviation from Standard.....	59
5.3.5	Test Configuration	59
5.3.6	Test Result	61
5.3.7	Photographs of Test Configuration	63
5.4	Radiated, Radio-frequency Electromagnetic Field Immunity Test	67
5.4.1	Test Specification.....	67
5.4.2	Test Instrument	68
5.4.3	Test Procedure.....	69
5.4.4	Deviation from Standard.....	70
5.4.5	Test Configuration	70
5.4.6	Test Result	71
5.4.7	Photographs of Test Configuration	72
5.5	Electrical Fast Transient / Burst Immunity Test	73
5.5.1	Test Specification.....	73
5.5.2	Test Instrument	73
5.5.3	Test Procedure.....	74
5.5.4	Deviation from Standard.....	74
5.5.5	Test Configuration	75
5.5.6	Test Result	76
5.5.7	Photographs of Test Configuration	77
5.6	Surge Immunity Test	78
5.6.1	Test Specification.....	78
5.6.2	Test Instrument	79
5.6.3	Test Procedure.....	79
5.6.4	Deviation from Standard.....	80
5.6.5	Test Configuration	80
5.6.6	Test Result	81
5.6.7	Photographs of Test Configuration	82
5.7	Conducted Disturbances Immunity Test.....	83
5.7.1	Test Specification.....	83
5.7.2	Test Instrument	83
5.7.3	Test Procedure.....	84
5.7.4	Deviation from Standard.....	84



5.7.5 Test Configuration 85

5.7.6 Test Result 86

5.7.7 Photographs of Test Configuration 87

5.8 Power Frequency Magnetic Field Immunity Test 88

5.8.1 Test Specification..... 88

5.8.2 Test Instrument 88

5.8.3 Test Procedure..... 88

5.8.4 Deviation from Standard..... 88

5.8.5 Test Configuration 89

5.8.6 Test Result 90

5.8.7 Photographs of Test Configuration 91

5.9 Voltage Dips & Short Interruptions Immunity Test..... 92

5.9.1 Test Specification..... 92

5.9.2 Test Instrument 92

5.9.3 Test Procedure..... 93

5.9.4 Deviation from Standard..... 93

5.9.5 Test Configuration 94

5.9.6 Test Result 95

5.9.7 Photographs of Test Configuration 96



History of this test report

Report No.	Issue date	Description
WD-EE-R-240374-A0	Dec. 06, 2024	Initial Issue

Declaration

This report is for your exclusive use. Any copying or replication of this report to or for any other person or entity, or use of our name or trademark, is permitted only with our prior written permission. This report sets forth our findings solely with respect to the test samples identified herein. The results set forth in this report are not indicative or representative of the quality or characteristics of the lot from which a test sample was taken or any similar or identical product unless specifically and expressly noted. Our report includes all of the tests requested by you and the results thereof based upon the information that you provided to us.



History of supplementary report

Report No.	Issue date	Description
WD-EE-R-240374-A0	Dec. 06, 2024	Original report

Declaration

This report is for your exclusive use. Any copying or replication of this report to or for any other person or entity, or use of our name or trademark, is permitted only with our prior written permission. This report sets forth our findings solely with respect to the test samples identified herein. The results set forth in this report are not indicative or representative of the quality or characteristics of the lot from which a test sample was taken or any similar or identical product unless specifically and expressly noted. Our report includes all of the tests requested by you and the results thereof based upon the information that you provided to us.

1 Certification

Product: Rugged Embedded System

Brand Name: Vecow

Model: ABP-4000

Series Model: ABP-4000 Series, ABP-4XXXXXXXXXXXX ("X" can be 0-9, A-Z or blank)

Applicant: Vecow Co., Ltd

Tested: Oct. 21 ~ Dec. 02, 2024

Standard: EN 55032: 2015 + A11: 2020, Class A
BS EN 55032: 2015 + A11: 2020
CISPR 32: 2015 + COR1: 2016
EN 55032: 2015 + A1: 2020, Class A
BS EN 55032: 2015 + A1: 2020
CISPR 32: 2015 + A1: 2019
EN 61000-3-2: 2014
EN IEC 61000-3-2: 2019 + A1: 2021
EN 61000-3-3: 2013 + A2: 2021
BS EN 61000-3-2: 2014
BS EN IEC 61000-3-2: 2019 + A1: 2021
BS EN 61000-3-3: 2013 + A2: 2021
EN 55035: 2017 + A11: 2020
BS EN 55035: 2017 + A11: 2020
IEC 61000-4-2: 2008
IEC 61000-4-3: 2020
IEC 61000-4-4: 2012
IEC 61000-4-5: 2014 + A1: 2017
IEC 61000-4-6: 2023
IEC 61000-4-8: 2009
IEC 61000-4-11: 2020 + COR2: 2022
EN 61000-4-2: 2009
EN IEC 61000-4-3: 2020
EN 61000-4-4: 2012
EN 61000-4-5: 2014 + A1: 2017
EN IEC 61000-4-6: 2023
EN 61000-4-8: 2010
EN IEC 61000-4-11: 2020

The above equipment (Model: ABP-4000) has been tested by **Wendell EMC & RF Laboratory**, and found compliance with the requirement of the above standards. The test record, data evaluation and Equipment Under Test (EUT) configurations represented herein are true and accurate accounts of the measurements of the sample's EMC characteristics under the conditions specified in this report.

Please note that the measurement uncertainty are provided for informational purpose only and are not used in determining the Pass/Fail results.

1.1 Summary of Result

The EUT has been tested according to the following specifications:

Emission				
Standard	Test Item	Limit	Result	Remark
EN 55032	Conducted disturbance at mains power ports	Class A	Pass	Meets the requirements
CISPR 32	Conducted disturbance at telecommunication port	Class A	Pass	Meets the requirements
	Radiated disturbance	Class A	Pass	Meets the requirements
EN IEC 61000-3-2	Harmonic current emission	Class A	Pass	The power consumption of EUT is less than 75W and no limits apply
EN 61000-3-3	Voltage fluctuations and flicker	-	Pass	Meets the requirements

Immunity			
Standard	Test Item	Result	Remark
IEC 61000-4-2	Electrostatic discharge	Pass	Meets the requirements of Performance Criterion B
IEC 61000-4-3	Radiated, radio-frequency electromagnetic field	Pass	Meets the requirements of Performance Criterion A
IEC 61000-4-4	Electrical fast transient / burst	Pass	Meets the requirements of Performance Criterion A
IEC 61000-4-5	Surge	Pass	Meets the requirements of Performance Criterion A
IEC 61000-4-6	Conducted disturbances	Pass	Meets the requirements of Performance Criterion A
IEC 61000-4-8	Power frequency magnetic field	Pass	Meets the requirements of Performance Criterion A
IEC 61000-4-11	Voltage dips and short interruptions	Pass	Meets the requirements of Voltage Dips: ✧ >95% reduction – Performance Criterion A ✧ 30% reduction - Performance Criterion A Voltage Interruptions: ✧ >95% reduction – Performance Criterion C

Note: Test record contained in the referenced test report relate only to the EUT sample and test item.

2 Laboratory Information

2.1 Measurement / Test Facility

Conducted disturbance at main power port, Conducted disturbance at telecommunication port, Harmonics, Flicker, ESD, EFT, Surge, CS, PFMF, DIP and Close Proximity Radiated fields test

W01: 5F-1, No.188, Baoqiao Rd., Xindian Dist., New Taipei City 23145, Taiwan (R.O.C)

RS, ESD and Surge test

W05: 1F-7, No.188, Baoqiao Rd., Xindian Dist., New Taipei City 23145, Taiwan (R.O.C)

Conducted disturbance at main power port, Conducted disturbance at telecommunication port, Radiated disturbance (9*6*6 Chamber) and ESD test

W08: No.119, Wugong 3rd Rd., Wugu Dist., New Taipei City 248, Taiwan (R.O.C)

ACCREDITATIONS

The laboratories are accredited and approved by the TAF according to ISO/IEC 17025.

2.2 Measurement Uncertainty

The measurement instrumentation uncertainty is evaluated according to CISPR 16-4-2.

This uncertainty represents an expanded uncertainty expressed at approximately the 95% confidence level using a coverage factor of $k=2$.

Wendell EMC & RF Laboratory U_{lab} is less than U_{cispr} , therefore compliance or non-compliance with a disturbance limit shall be determined in the following manner.

- compliance is deemed to occur if no measured disturbance level exceeds the disturbance limit;
- non-compliance is deemed to occur if any measured disturbance level exceeds the disturbance limit.

Please note that the measurement uncertainty (U_{lab}) is provided for informational purpose only and is not used in determining the Pass/Fail results.

2.2.1 Conducted Emission Measurement

Test Site	Frequency Range	dB (U_{lab})	Note
W01-CE	150 kHz ~ 30 MHz	2.84	LISN
W08-CE	150 kHz ~ 30 MHz	2.72	LISN

2.2.2 Conducted Emission at Telecommunication Port Measurement

Test Site	Frequency Range	dB (U_{lab})	Note
W01-CE	150 kHz ~ 30 MHz	2.85	ISN
W01-CE	150 kHz ~ 30 MHz	2.11	Current Probe
W08-CE	150 kHz ~ 30 MHz	2.64	ISN

2.2.3 Radiated Emission Measurement

Test Site	Frequency Range	Ant	dB (U_{lab})	Note
W08-966-1	30 MHz ~ 200 MHz	V	3.50	N/A
	30 MHz ~ 200 MHz	H	2.96	N/A
	200 MHz ~ 1000 MHz	V	5.09	N/A
	200 MHz ~ 1000 MHz	H	3.41	N/A
	1 GHz ~ 6 GHz	V	4.37	N/A
	1 GHz ~ 6 GHz	H	4.30	N/A



3 General Information

3.1 Description of Equipment Under Test

Product	Rugged Embedded System
Brand	Vecow
Model	ABP-4000
Series Model	ABP-4000 Series, ABP-4XXXXXXXXXX ("X" can be 0-9, A-Z or blank)
Applicant	Vecow Co., Ltd
Received Date	Oct. 15, 2024
EUT Power Rating	24Vdc (from adapter)
Model Differences	The models are electrically identical, different models no. are for marketing purpose. The series model information is provided by client.
Operating System	Windows 11 Pro version: 22H2
Data Cable Supplied	N/A
Accessory Device	N/A
I/O Port	Please refer to the User's Manual

Note:

- The EUT uses the follow adapter:

Adapter (support unit only)	
Brand	FSP
Model	FSP120-AAAN2
Input Power	100-240Vac, 1.8A, 50-60Hz
Output Power	24Vdc, 5A
Power line	Input: 1.8m non-shielded cable Output: 1.4m non-shielded cable with 1 core

- The EUT contains following components.

Item	Brand	Model	Spec.	Qty.
Main Board	-	ABP-4000	Rev. C	1
CPU	Intel	13th Gen Intel® Core™ i7-1365UE	1.70 GHz	1
RAM	Vecow	VMD4NIS-32G00C	32GB DDR4 3200 W/T SODIMM	2
M.2 SSD	innodisk	DEM28-C12DD1KWAQF-H03	M.2(P80) 3TE6 512GB	1

- The EUT's highest operating frequency is 1.7GHz. Therefore the radiated emission is tested up to 6GHz.

3.2 Description of Measurement / Test Modes

Test results are presented in the report as below.

Test Mode	Measurement / Test Condition
Conducted Emission Measurement	
-	AC-DC Adapter mode
Conducted Emission at Telecommunication Port Measurement	
-	AC-DC Adapter mode, LAN (100Mbps/1Gbps/2.5Gbps)
Radiated Emission 30MHz ~ 1GHz Measurement	
-	AC-DC Adapter mode
Radiated Emission above 1GHz Measurement	
-	AC-DC Adapter mode
Harmonic & Flicker Measurement	
-	AC-DC Adapter mode
Immunity Test	
-	AC-DC Adapter mode

3.3 Description of Operating Condition

- a. The EUT placed on test table.
- b. Prepare PC to act as a communication partner and placed it outside of testing area.
- c. The EUT was connected to the PC with LAN cable.
- d. The communication partner sent data to EUT by command "ping" via LAN.
- e. The EUT read / write data with Internal SSD & External HDD/SSD.
- f. The EUT run test program BurnIN.exe to enable all functions
- g. The EUT sent Color Bar ITU-R.BT471-1 signal to monitor and displayed on screen.
- h. The microphone sent voice signal to EUT.
- i. The EUT sent voice signal to earphone.



3.4 Description of Associated Equipment

The EUT has been conducted testing with other necessary accessories or support units.

Item	Equipment	Brand	Model No.	Serial No.	FCC ID	Data Cable	Power Cable	Remark
1	Desktop PC	DELL	D19M	N/A	PPD-QCN FA335	20m CAT.5E non-shielded LAN cable	AC: 1.8m non-shielded cable	-
2	Desktop PC	DELL	D24M	N/A	PD93165NG	20m CAT.5E non-shielded LAN cable	AC: 1.8m non-shielded cable	-
3	4K monitor	PHILIPS	276E8V	UKC19260004 58	FCC DoC Approved	1.5m shielded HDMI cable	AC: 1.8m non-shielded cable DC: 1.4m non-shielded cable with 1 core	-
4	4K monitor	HP	HP 27f 4k Display	3CM01935TF	FCC DoC Approved	1.5m shielded HDMI cable with 2 cores	AC: 1.8m non-shielded cable DC: 1.4m non-shielded cable with 1 core	-
5	4K Monitor	ASUS	XG27UCS	S5LMTF2007 65	FCC SDoC Approved	1.5m shielded HDMI cable with 2 cores	AC: 1.8m non-shielded cable	-
6	4K Monitor	ASUS	XG27UCS	S7LMT011954	FCC SDoC Approved	1.5m shielded HDMI cable	AC: 1.8m non-shielded cable	-
7	Keyboard	DELL	KB216t	CN-0W33XP- L0300 -7C1-15UP	FCC SDoC Approved	1.5m non-shielded USB cable	N/A	-
8	Mouse	DELL	MS116	CN-0DV0RH- L0300 -7C1-15UP	FCC SDoC Approved	1.5m non-shielded USB cable	N/A	-
9	Earphone & Microphone	Avier	AEP-MM	N/A	N/A	1.2m non-shielded audio cable	N/A	-
10	External Hard Drive (x2)	Transcend	TS1TSJ25C 3N	D62397-0399	FCC SDoC Approved	1m shielded USB cable	N/A	-
11	External Portable SSD	Transcend	TS120GES D240C	F96474-0001	FCC SDoC Approved	1m shielded USB cable	N/A	-
12	RS232 terminator (x2)	N/A	N/A	N/A	N/A	N/A	N/A	Supplied by client

- Note:**
1. The core(s) is(are) originally attached to the cable(s).
 2. Item 1-2 acted as communication partners to transfer data.

3.5 Configuration of Equipment Under Test

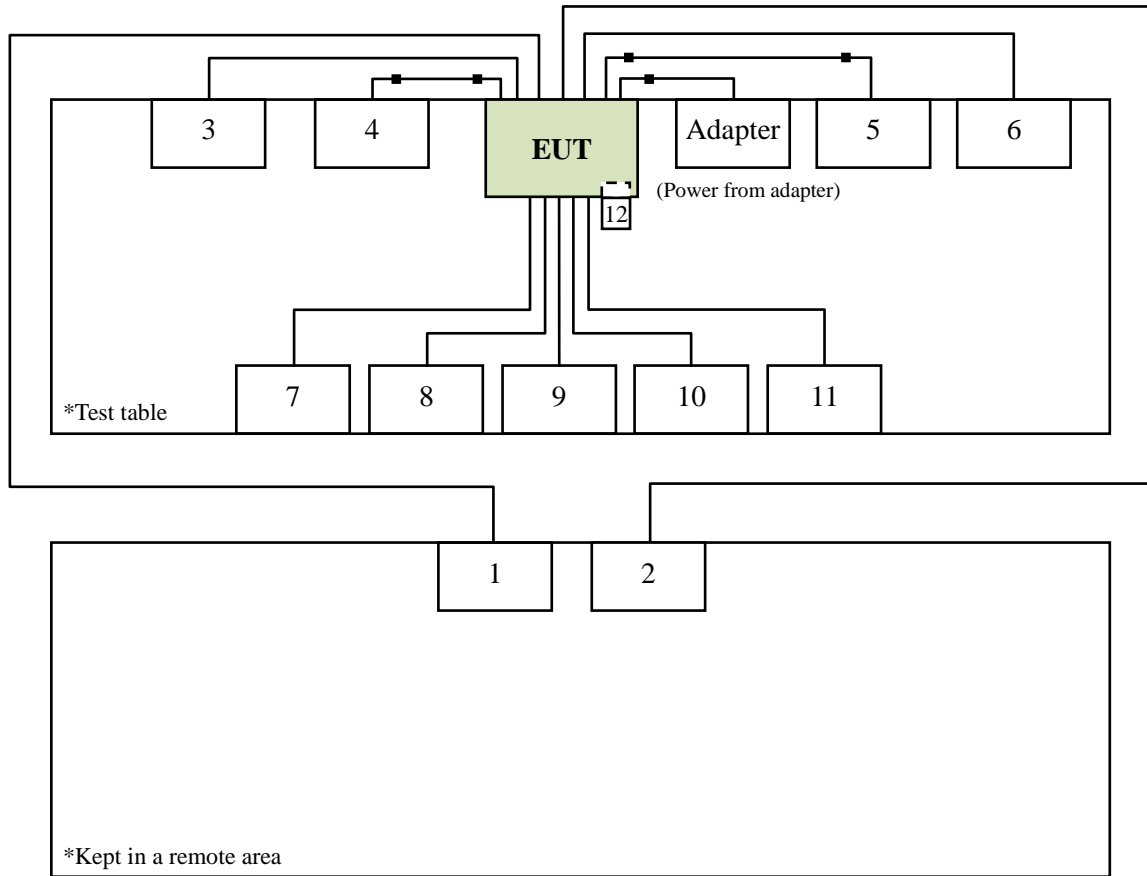

4 Emission Measurement

4.1 Conducted Emission Measurement

4.1.1 Limit of Conducted Emission Measurement

Class A equipment:

Requirements for conducted emissions from the AC mains power ports of Class A equipment			
Frequency (MHz)	Measurement		Class A limits dB(μ V)
	Coupling device	Detector type/ bandwidth	
0.15 to 0.5	AMN	Quasi Peak / 9 kHz	79
0.5 to 30			73
0.15 to 0.5	AMN	Average / 9 kHz	66
0.5 to 30			60

Class B equipment:

Requirements for conducted emissions from the AC mains power ports of Class B equipment			
Frequency (MHz)	Measurement		Class B limits dB(μ V)
	Coupling device	Detector type/ bandwidth	
0.15 to 0.5	AMN	Quasi Peak / 9 kHz	66 to 56*
0.5 to 5			56
5 to 30			60
0.15 to 0.5	AMN	Average / 9 kHz	56 to 46*
0.5 to 5			46
5 to 30			50

* Decreases with the logarithm of the frequency.

- Note:**
- The lower limit shall apply at the transition frequencies.
 - Detector function in the form: QP = Quasi Peak, AVG = Average
 - The result calculated as following:
 Measurement Value = Reading Level + Correct Factor
 Correct Factor = LISN Factor + Cable Loss + Transient Limiter (If use)
 Margin Level = Measurement Value – Limit Value
 - Applicable to AC mains power ports.



4.1.2 Measurement Instrument

Test Site: W01-CE					
Item	Equipment	Manufacturer	Model	Meter No.	Calibration Date
1	TWO-LINE V-NETWORK	R&S	ENV216	CT-1-025-1	Jun. 05, 2024
2	Pulse limiter	R&S	ESH3-Z2	CT-2-015	Jun. 06, 2024
3	EMI Test Receiver	R&S	ESCI	CT-1-024	Jun. 06, 2024
4	Artificial Mains Network (AMN)	SCHWARZBECK	NSLK 8127	CT-1-104-1	Jun. 06, 2024
5	RF Cable	MVE	200200.400LL .500A	CT-9-101	Jun. 06, 2024
6	50ohm Termination	N/A	N/A	CT-1-065-1	May 30, 2024
7	Measurement Software	EZ-EMC	Ver: EMC-CON 3A1	CT-3-012	No calibration request

Note: 1. The calibration interval of the above test instruments is 12 months.

Test Site: W08-CE					
Item	Equipment	Manufacturer	Model	Meter No.	Calibration Date
1	TWO-LINE V-NETWORK	R&S	ENV216	CT-1-025-2	Jun. 20, 2024
2	RF Cable	EMCI	EMCCFD300-BM-BM-5000	CT-1-107-2	Jun. 24, 2024
3	EMI Test Receiver	R&S	ESR3	CT-1-103	Jun. 20, 2024
4	Artificial Mains Network (AMN)	SCHWARZBECK	NSLK 8127 RC	CT-1-104-1R C	Jun. 20, 2024
5	Transient Limiter	Electro-Metrics	EM-7600	CT-1-026	Jun. 24, 2024
6	50ohm Termination	N/A	N/A	CT-1-109-1	Jun. 20, 2024
7	Measurement Software	EZ-EMC	Ver: EMC-CON 3A1	CT-3-012	No calibration request

Note: 1. The calibration interval of the above test instruments is 12 months.

4.1.3 Measurement Procedure

- a. The table-top equipment under test was placed 0.8 meter height wooden table from the horizontal ground plane with EUT being connected to power source through a line impedance stabilization network (LISN). The floor-standing equipment under test was placed insulation support unit from the horizontal ground plane. The LISN at least be 0.8 meter from nearest chassis of equipment under test.
- b. The line impedance stabilization network (LISN) provides 50 ohm/50uH of coupling impedance for the measuring instrument. All associated equipment powered from additional LISN(s).
- c. Interrelating cables that hang closer than 0.4 meter to the ground plane shall be folded back and forth in the center forming a bundle. All I/O cables were positioned to simulate typical usage.
- d. The loads and/or devices simulating typical operating conditions shall be connected to at least one of each type of interface port of the equipment under test. If loading (or terminating) with a device of actual usage is not feasible, the port should be loaded with a simulator. Where these options are not practical the port shall be loaded by the application of a typical impedance considering both the common and differential modes.
- e. The EMI test receiver connected to the line impedance stabilization network (LISN) powering the equipment. The measurements shall be limited to the operating ranges of voltage and frequency as specified for the equipment under test, having regard to the supply voltage and frequency for the intended market of the equipment under test.
- f. The EMI test receiver scanned from 150kHz to 30MHz for emissions in each of modes. A scan was taken on both power lines, Line and Neutral, recording at least six highest emission amplitude.
- g. The equipment under test and cable configuration of the above highest emission amplitude were recorded.

4.1.4 Deviation from Standard

No deviation

4.1.5 Measurement Configuration

< Table-Top equipment under test >

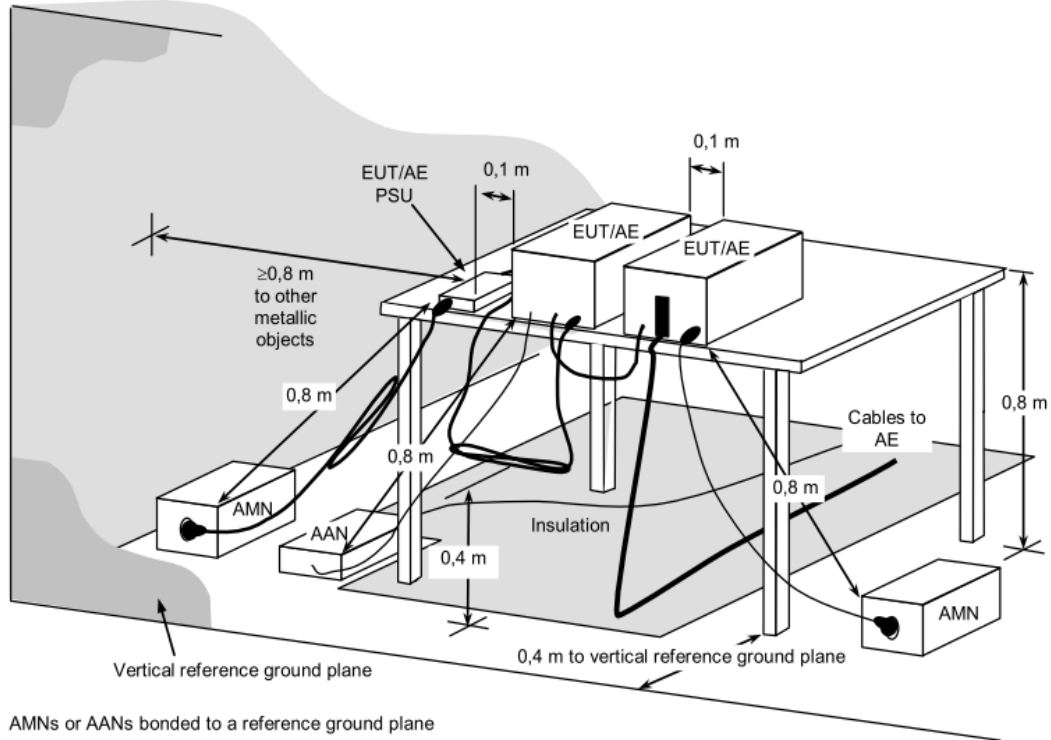

< Floor-Standing equipment under test >

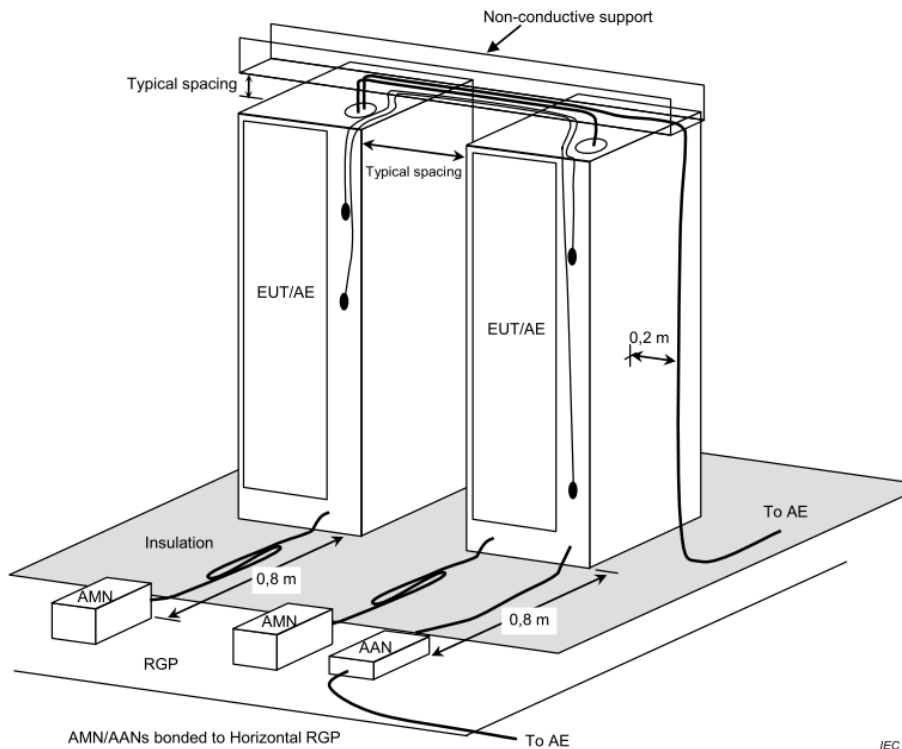

Note: Please refer to 4.1.7 for the actual test configuration.



4.1.6 Measurement Result

Test Voltage	230Vac, 50Hz	Frequency Range	0.15 ~ 30 MHz
Environmental Conditions	22°C, 51% RH	6dB Bandwidth	9 kHz
Test Date	2024/11/29	Phase	L
Tested by	Guanwei Liao	Test Site	W01-CE

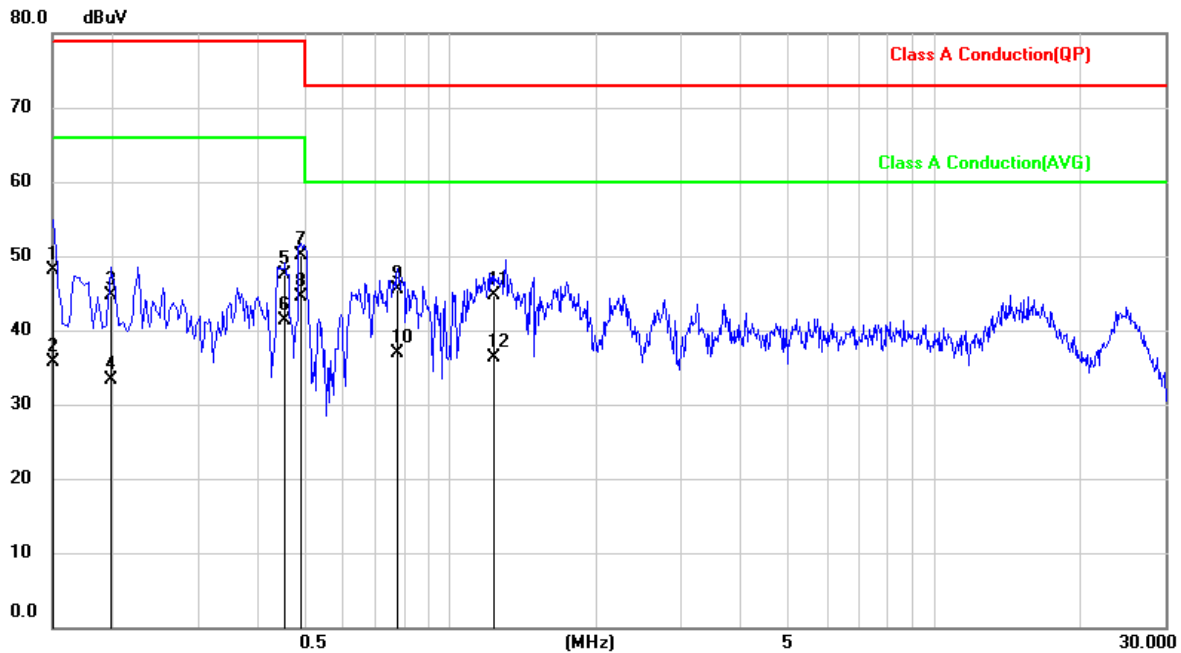

No.	Frequency (MHz)	Reading Level (dBμV)	Correct Factor (dB)	Measurement (dBμV)	Limit (dBμV)	Margin (dB)	Detector
1	0.1503	38.19	9.91	48.10	79.00	-30.90	QP
2	0.1503	25.83	9.91	35.74	66.00	-30.26	AVG
3	0.1992	34.81	9.92	44.73	79.00	-34.27	QP
4	0.1992	23.42	9.92	33.34	66.00	-32.66	AVG
5	0.4545	37.51	9.93	47.44	79.00	-31.56	QP
6	0.4545	31.40	9.93	41.33	66.00	-24.67	AVG
7	0.4913	40.26	9.93	50.19	79.00	-28.81	QP
8	0.4913	34.53	9.93	44.46	66.00	-21.54	AVG
9	0.7787	35.62	9.95	45.57	73.00	-27.43	QP
10	0.7787	27.04	9.95	36.99	60.00	-23.01	AVG
11	1.2361	34.82	9.95	44.77	73.00	-28.23	QP
12	1.2361	26.30	9.95	36.25	60.00	-23.75	AVG

Remark:

1. QP = Quasi Peak, AVG = Average
2. Correct Factor = LISN Factor + Cable Loss + Transient Limiter (If use)
3. Measurement Value = Reading Level + Correct Factor
4. Margin Level = Measurement Value - Limit Value



Test Voltage	230Vac, 50Hz	Frequency Range	0.15 ~ 30 MHz
Environmental Conditions	22°C, 51% RH	6dB Bandwidth	9 kHz
Test Date	2024/11/29	Phase	N
Tested by	Guanwei Liao	Test Site	W01-CE

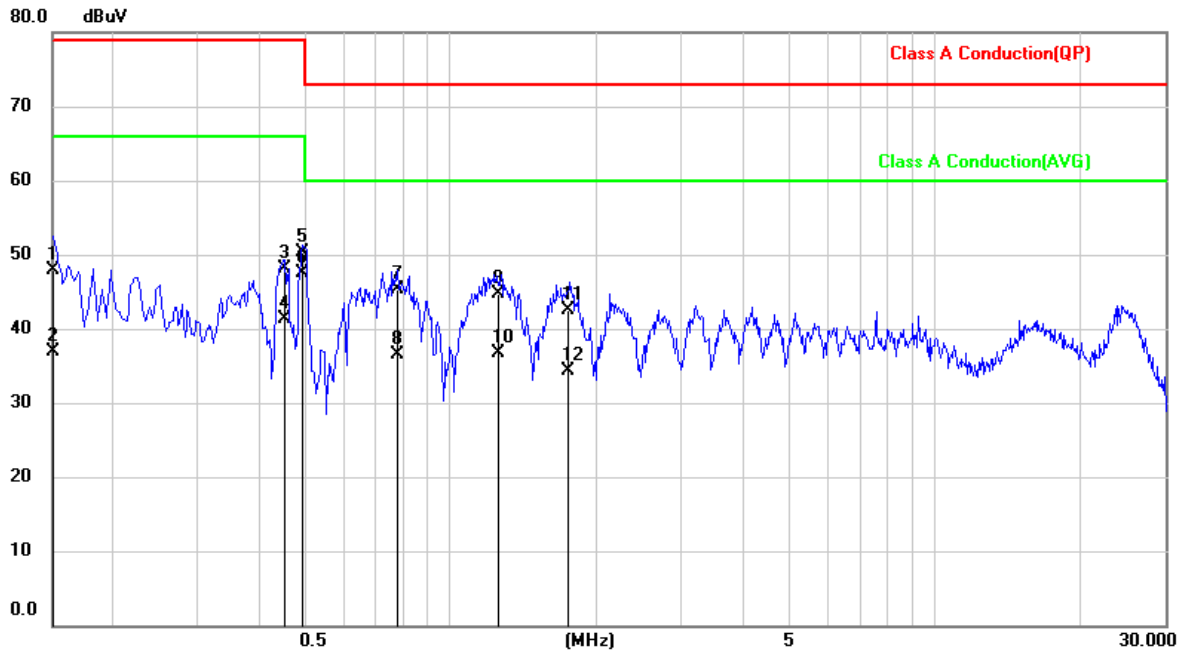

No.	Frequency (MHz)	Reading Level (dBμV)	Correct Factor (dB)	Measurement (dBμV)	Limit (dBμV)	Margin (dB)	Detector
1	0.1508	37.98	9.90	47.88	79.00	-31.12	QP
2	0.1508	27.09	9.90	36.99	66.00	-29.01	AVG
3	0.4544	38.10	9.91	48.01	79.00	-30.99	QP
4	0.4544	31.47	9.91	41.38	66.00	-24.62	AVG
5	0.4934	40.48	9.91	50.39	79.00	-28.61	QP
6	0.4934	37.67	9.91	47.58	66.00	-18.42	AVG
7	0.7771	35.35	9.93	45.28	73.00	-27.72	QP
8	0.7771	26.57	9.93	36.50	60.00	-23.50	AVG
9	1.2640	34.67	9.95	44.62	73.00	-28.38	QP
10	1.2640	26.85	9.95	36.80	60.00	-23.20	AVG
11	1.7432	32.60	9.95	42.55	73.00	-30.45	QP
12	1.7432	24.29	9.95	34.24	60.00	-25.76	AVG

Remark: 1. QP = Quasi Peak, AVG = Average
 2. Correct Factor = LISN Factor + Cable Loss + Transient Limiter (If use)
 3. Measurement Value = Reading Level + Correct Factor
 4. Margin Level = Measurement Value - Limit Value



Test Voltage	110Vac, 60Hz	Frequency Range	0.15 ~ 30 MHz
Environmental Conditions	22°C, 51% RH	6dB Bandwidth	9 kHz
Test Date	2024/11/29	Phase	L
Tested by	Guanwei Liao	Test Site	W01-CE

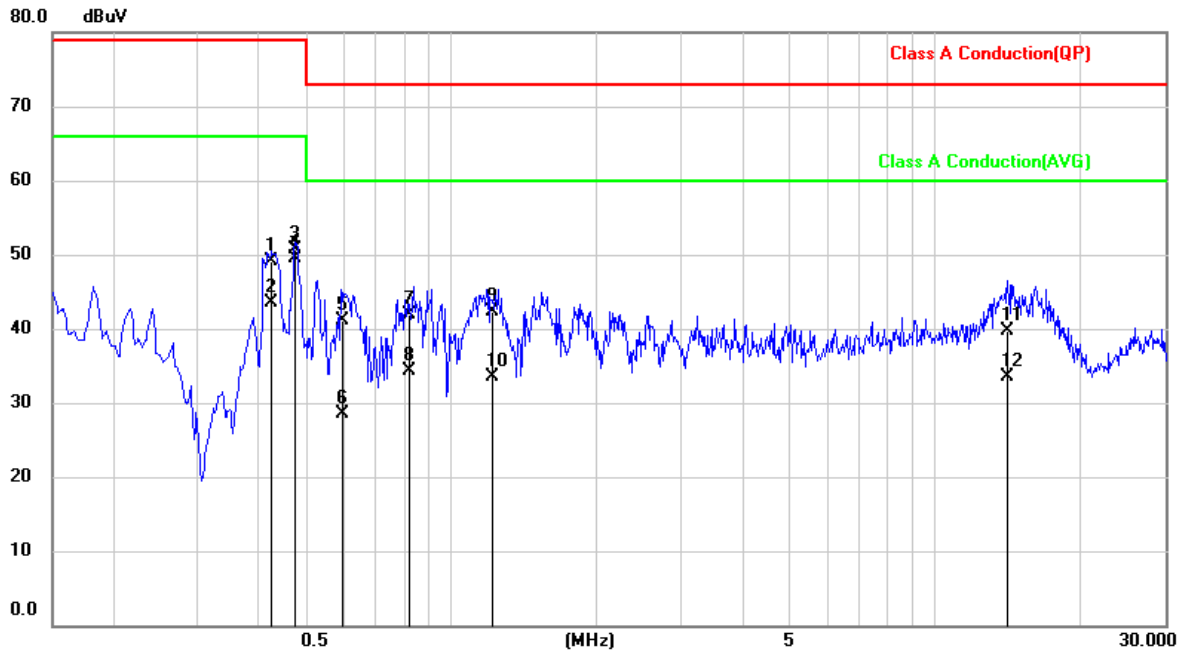

No.	Frequency (MHz)	Reading Level (dBμV)	Correct Factor (dB)	Measurement (dBμV)	Limit (dBμV)	Margin (dB)	Detector
1	0.4273	39.12	9.93	49.05	79.00	-29.95	QP
2	0.4273	33.56	9.93	43.49	66.00	-22.51	AVG
3	0.4783	40.83	9.93	50.76	79.00	-28.24	QP
4	0.4783	39.58	9.93	49.51	66.00	-16.49	AVG
5	0.5963	31.24	9.93	41.17	73.00	-31.83	QP
6	0.5963	18.52	9.93	28.45	60.00	-31.55	AVG
7	0.8277	31.92	9.95	41.87	73.00	-31.13	QP
8	0.8277	24.33	9.95	34.28	60.00	-25.72	AVG
9	1.2209	32.27	9.95	42.22	73.00	-30.78	QP
10	1.2209	23.58	9.95	33.53	60.00	-26.47	AVG
11	14.1920	29.45	10.21	39.66	73.00	-33.34	QP
12	14.1920	23.38	10.21	33.59	60.00	-26.41	AVG

Remark: 1. QP = Quasi Peak, AVG = Average
 2. Correct Factor = LISN Factor + Cable Loss + Transient Limiter (If use)
 3. Measurement Value = Reading Level + Correct Factor
 4. Margin Level = Measurement Value - Limit Value



Test Voltage	110Vac, 60Hz	Frequency Range	0.15 ~ 30 MHz
Environmental Conditions	22°C, 51% RH	6dB Bandwidth	9 kHz
Test Date	2024/11/29	Phase	N
Tested by	Guanwei Liao	Test Site	W01-CE

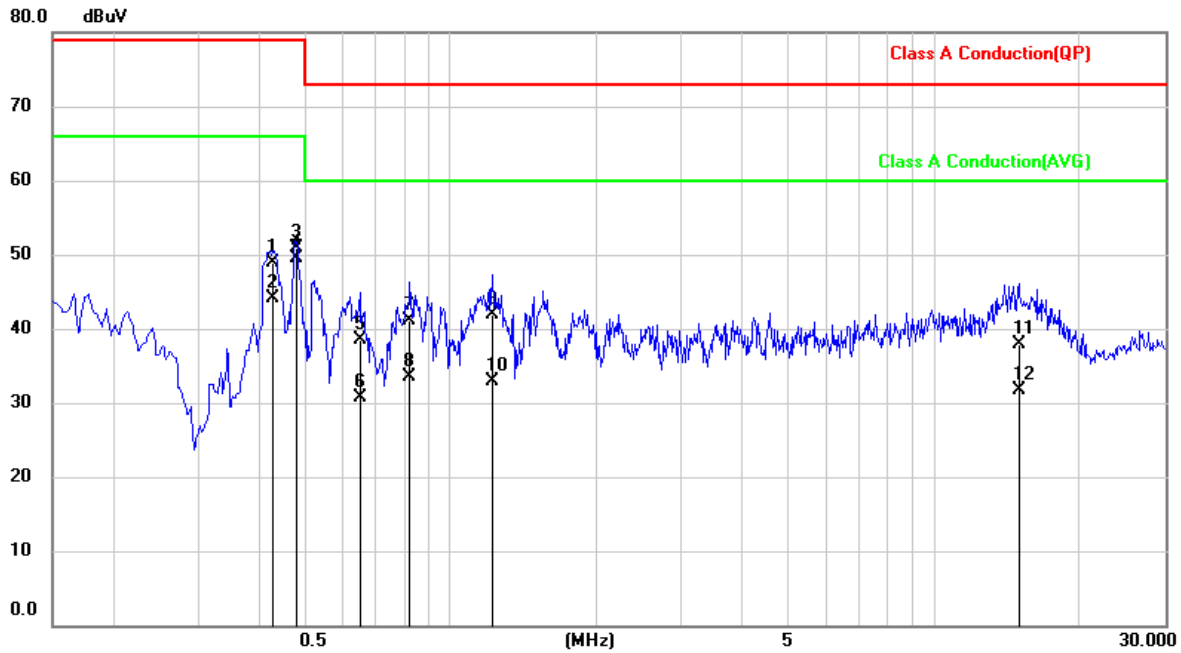

No.	Frequency (MHz)	Reading Level (dBμV)	Correct Factor (dB)	Measurement (dBμV)	Limit (dBμV)	Margin (dB)	Detector
1	0.4282	39.06	9.91	48.97	79.00	-30.03	QP
2	0.4282	34.28	9.91	44.19	66.00	-21.81	AVG
3	0.4786	41.01	9.91	50.92	79.00	-28.08	QP
4	0.4786	39.59	9.91	49.50	66.00	-16.50	AVG
5	0.6538	28.56	9.91	38.47	73.00	-34.53	QP
6	0.6538	20.74	9.91	30.65	60.00	-29.35	AVG
7	0.8222	31.10	9.93	41.03	73.00	-31.97	QP
8	0.8222	23.50	9.93	33.43	60.00	-26.57	AVG
9	1.2182	31.89	9.93	41.82	73.00	-31.18	QP
10	1.2182	22.91	9.93	32.84	60.00	-27.16	AVG
11	15.0363	27.60	10.22	37.82	73.00	-35.18	QP
12	15.0363	21.40	10.22	31.62	60.00	-28.38	AVG

Remark: 1. QP = Quasi Peak, AVG = Average
 2. Correct Factor = LISN Factor + Cable Loss + Transient Limiter (If use)
 3. Measurement Value = Reading Level + Correct Factor
 4. Margin Level = Measurement Value - Limit Value

4.1.7 Photographs of Measurement Configuration

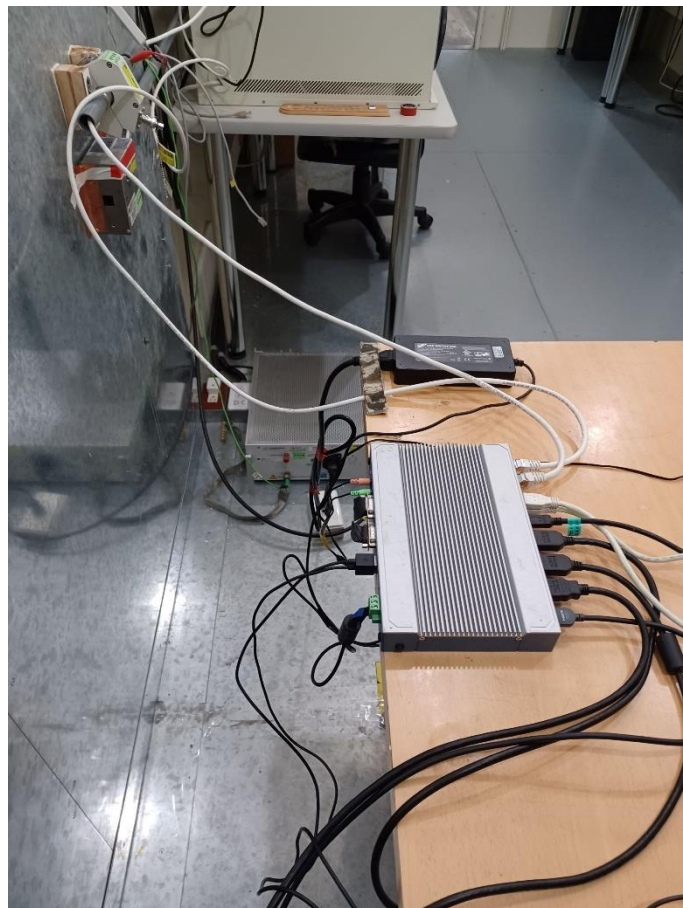
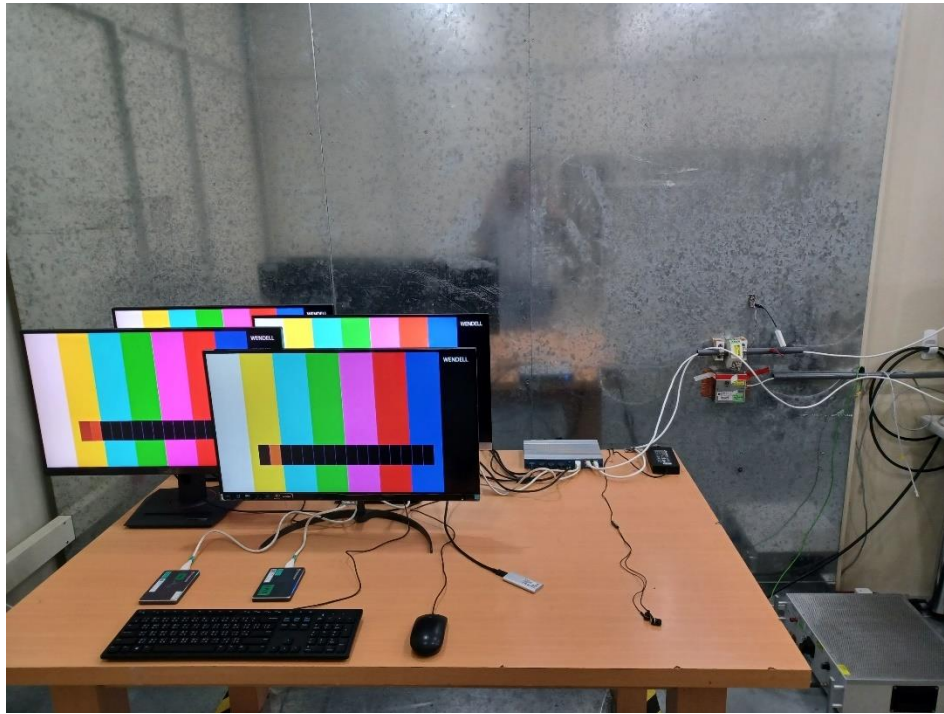

4.2 Conducted Emission at Telecommunication Port Measurement

4.2.1 Limit of Conducted Emission at Telecommunication Port Measurement

Class A equipment:

Requirements for asymmetric mode conducted emissions from Class A equipment			
Frequency (MHz)	Measurement		Class A limits dB(μ V)
	Coupling device	Detector type/ bandwidth	
0.15 to 0.5	AAN	Quasi Peak / 9 kHz	97 to 87*
0.5 to 30			87
0.15 to 0.5	AAN	Average / 9 kHz	84 to 74*
0.5 to 30			74

* Decreases with the logarithm of the frequency.

Class B equipment:

Requirements for asymmetric mode conducted emissions from Class B equipment			
Frequency (MHz)	Measurement		Class B limits dB(μ V)
	Coupling device	Detector type/ bandwidth	
0.15 to 0.5	AAN	Quasi Peak / 9 kHz	84 to 74*
0.5 to 30			74
0.15 to 0.5	AAN	Average / 9 kHz	74 to 64*
0.5 to 30			64

* Decreases with the logarithm of the frequency.

- Note:**
1. The lower limit shall apply at the transition frequencies.
 2. Detector function in the form: QP = Quasi Peak, AVG = Average
 3. The result calculated as following:
 Measurement Value = Reading Level + Correct Factor
 Correct Factor = ISN Factor + Cable Loss + Transient Limiter (If use)
 Margin Level = Measurement Value – Limit Value
 4. Applicable to wired network ports, optical fiber ports with metallic shield or tension members and antenna ports.

Class A equipment:

Requirements for asymmetric mode conducted emissions from Class A equipment			
Frequency (MHz)	Measurement		Class A limits dB(μA)
	Coupling device	Detector type/ bandwidth	
0.15 to 0.5	Current Probe	Quasi Peak / 9 kHz	53 to 43*
0.5 to 30			43
0.15 to 0.5	Current Probe	Average / 9 kHz	40 to 30*
0.5 to 30			30

* Decreases with the logarithm of the frequency.

Class B equipment:

Requirements for asymmetric mode conducted emissions from Class B equipment			
Frequency (MHz)	Measurement		Class B limits dB(μA)
	Coupling device	Detector type/ bandwidth	
0.15 to 0.5	Current Probe	Quasi Peak / 9 kHz	40 to 30*
0.5 to 30			30
0.15 to 0.5	Current Probe	Average / 9 kHz	30 to 20*
0.5 to 30			20

* Decreases with the logarithm of the frequency.

- Note:**
- The lower limit shall apply at the transition frequencies.
 - Detector function in the form: QP = Quasi Peak, AVG = Average
 - The test result calculated as following:
 Measurement Value = Reading Level + Correct Factor
 Correct Factor = Current Probe Factor + Cable Loss + Transient Limiter (If use)
 Margin Level = Measurement Value – Limit Value
 - Applicable to wired network ports, optical fiber ports with metallic shield or tension members and antenna ports.



4.2.2 Measurement Instrument

Test Site: W01-CE					
Item	Equipment	Manufacturer	Model	Meter No.	Calibration Date
1	TWO-LINE V-NETWORK	R&S	ENV216	CT-1-025-1	Jun. 05, 2024
2	EMI Test Receiver	R&S	ESCI	CT-1-024	Jun. 06, 2024
3	Impedance Stabilization Network	TESEQ	T8-CAT6	CT-1-105	Jun. 12, 2024
4	Artificial Mains Network (AMN)	SCHWARZBECK	NSLK 8127	CT-1-104-1	Jun. 06, 2024
5	RF Cable	MVE	200200.400LL .500A	CT-9-101	Jun. 06, 2024
6	50ohm Termination	N/A	N/A	CT-1-065-2	Jun. 06, 2024
7	Measurement Software	EZ-EMC	Ver: EMC-CON 3A1	CT-3-012	No calibration request
8	Current Probe	TESEQ	CSP 9160A	CT-1-106	Jun. 12, 2023

- Note:** 1. The calibration interval of the above test instruments is 12 months.
2. The calibration interval of the current probe is 24 months.

Test Site: W08-CE					
Item	Equipment	Manufacturer	Model	Meter No.	Calibration Date
1	TWO-LINE V-NETWORK	R&S	ENV216	CT-1-025-2	Jun. 20, 2024
2	RF Cable	EMCI	EMCCFD300-BM-BM-5000	CT-1-107-2	Jun. 24, 2024
3	EMI Test Receiver	R&S	ESR3	CT-1-103	Jun. 20, 2024
4	Artificial Mains Network (AMN)	SCHWARZBECK	NSLK 8127 RC	CT-1-104-1R C	Jun. 20, 2024
5	Four Balanced Pair ISN	FCC	F-071115-105 7-1-09	CT-1-027	Jun. 24, 2024
6	50ohm Termination	N/A	N/A	CT-1-109-2	Jun. 20, 2024
7	Measurement Software	EZ-EMC	Ver: EMC-CON 3A1	CT-3-012	No calibration request

- Note:** 1. The calibration interval of the above test instruments is 12 months.

4.2.3 Measurement Procedure

- a. The table-top equipment under test was placed 0.8 meter height wooden table from the horizontal ground plane with EUT being connected to power source through a line impedance stabilization network (LISN). The floor-standing equipment under test was placed insulation support unit from the horizontal ground plane. The LISN at least be 0.8 meter from nearest chassis of equipment under test.
- b. The line impedance stabilization network (LISN) provides 50 ohm/50uH of coupling impedance for the measuring instrument. All associated equipment powered from additional LISN(s).
- c. Interrelating cables that hang closer than 0.4 meter to the ground plane shall be folded back and forth in the center forming a bundle. All I/O cables were positioned to simulate typical usage.
- d. The loads and/or devices simulating typical operating conditions shall be connected to at least one of each type of interface port of the equipment under test. If loading (or terminating) with a device of actual usage is not feasible, the port should be loaded with a simulator. Where these options are not practical the port shall be loaded by the application of a typical impedance considering both the common and differential modes.
- e. For unshielded / unshielded twisted pair measurement:
The impedance stabilization network (ISN) at least 0.8 meter from nearest chassis of equipment under test. The communication function of equipment under test was executed in normal condition. ISN was connected between EUT and associated equipment and ISN was connected directly to reference ground plane.
- f. For shielded / shielded twisted pair measurement:
The current probe to EUT horizontal distance may be increased to 0.8 meter. Break the external protective insulation (exposing the shield) and connect a 150 Ω resistor with a physical connection between the cable screen and the RGP. The 150 Ω resistor shall be \leq 0.3 meter from the outside surface of the screen to ground.
- g. The EMI test receiver scanned from 150kHz to 30MHz for emissions in each of modes. For wired network ports supporting Ethernet traffic, that can operate at multiple rates, measurements may be limited to mode in which the EUT operates at its maximum rate. Emission frequency and amplitude were recorded, recording at least six highest emissions.
- h. The equipment under test and cable configuration of the above highest emission amplitude were recorded.

4.2.4 Deviation from Standard

No deviation

4.2.5 Measurement Configuration

< Table-Top equipment under test for unshielded / unshielded twisted pair >

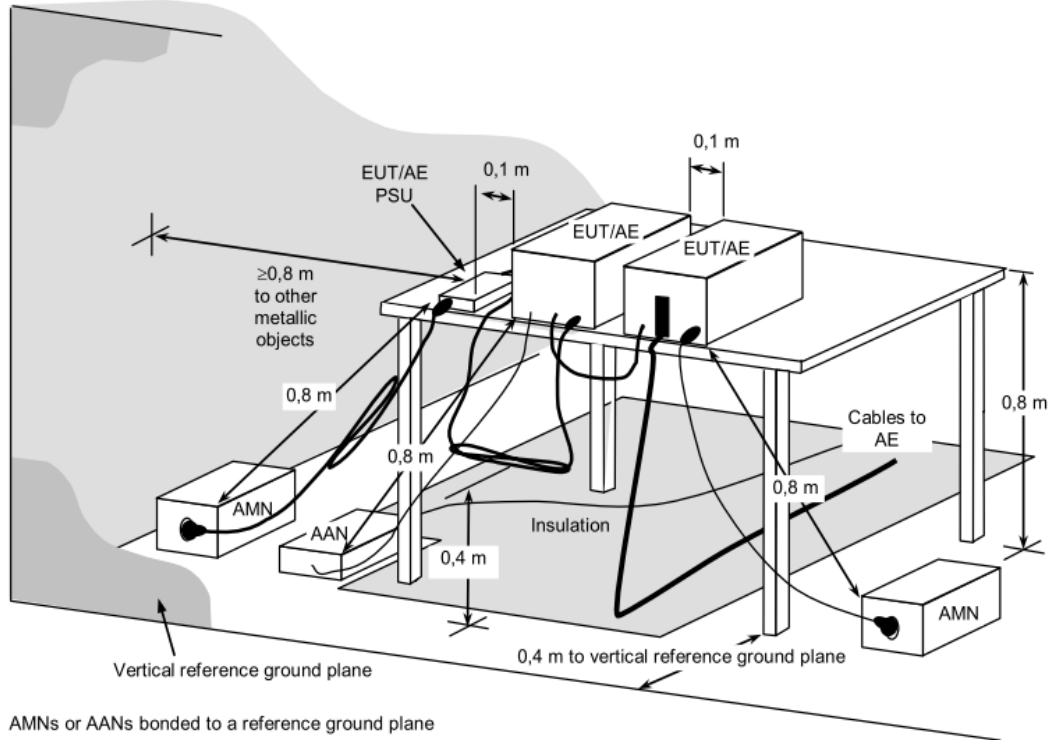

< Table-Top equipment under test for shielded / shielded twisted pair >

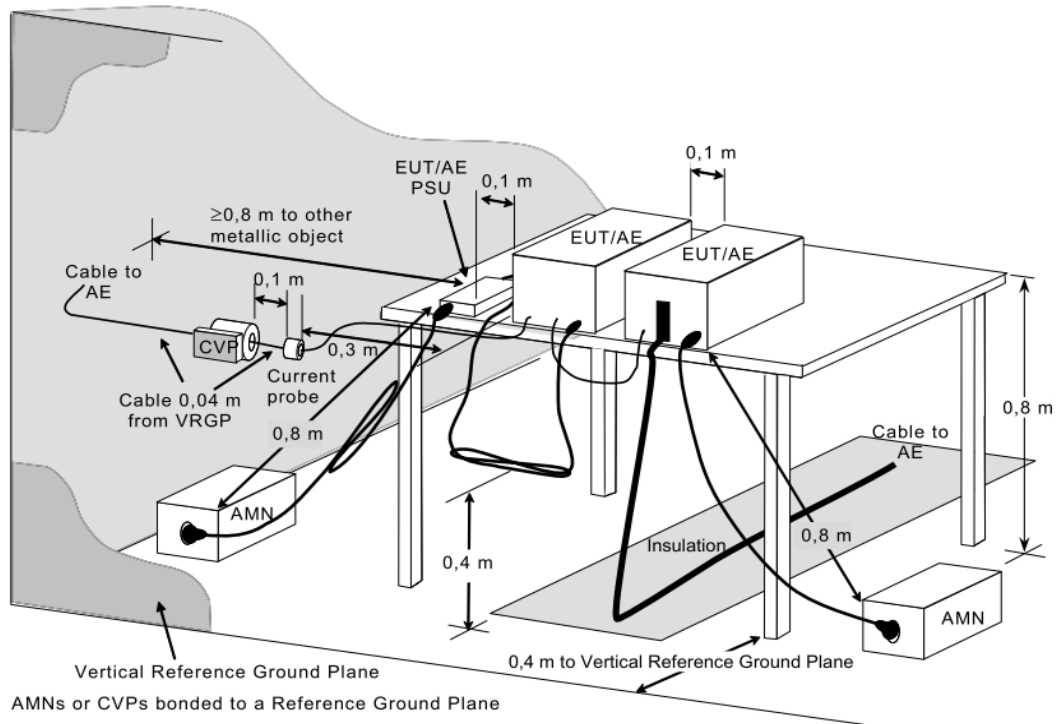

Note: Please refer to the 4.2.7 for the actual test configuration.

4.2.6 Measurement Result

Test Voltage	230Vac, 50Hz	Frequency Range	0.15 ~ 30 MHz
Environmental Conditions	22°C, 51% RH	6dB Bandwidth	9 kHz
Test Date	2024/11/29	Test Condition	LAN port (100Mbps)
Tested by	Guanwei Liao	Test Site	W01-CE

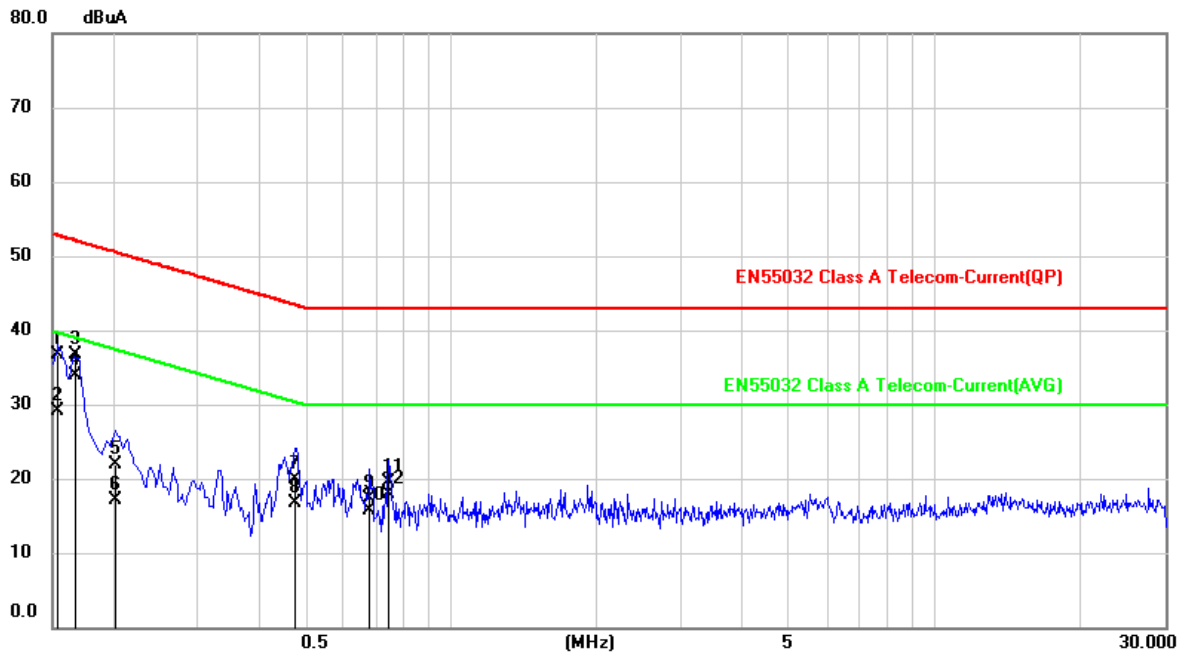

No.	Frequency (MHz)	Reading Level (dBμA)	Correct Factor (dB)	Measurement (dBμA)	Limit (dBμA)	Margin (dB)	Detector
1	0.1532	26.05	10.56	36.61	52.82	-16.21	QP
2	0.1532	18.62	10.56	29.18	39.82	-10.64	AVG
3	0.1677	26.10	10.51	36.61	52.07	-15.46	QP
4	0.1677	23.44	10.51	33.95	39.07	-5.12	AVG
5	0.2031	11.43	10.39	21.82	50.48	-28.66	QP
6	0.2031	6.70	10.39	17.09	37.48	-20.39	AVG
7	0.4747	9.59	10.32	19.91	43.43	-23.52	QP
8	0.4747	6.33	10.32	16.65	30.43	-13.78	AVG
9	0.6840	7.05	10.32	17.37	43.00	-25.63	QP
10	0.6840	5.36	10.32	15.68	30.00	-14.32	AVG
11	0.7456	9.16	10.32	19.48	43.00	-23.52	QP
12	0.7456	7.51	10.32	17.83	30.00	-12.17	AVG

Remark: 1. QP = Quasi Peak, AVG = Average
 2. Correct Factor = ISN Factor (or Current Probe Factor) + Cable Loss + Transient Limiter (If use)
 3. Measurement Value = Reading Level + Correct Factor
 4. Margin Level = Measurement Value – Limit Value



Test Voltage	230Vac, 50Hz	Frequency Range	0.15 ~ 30 MHz
Environmental Conditions	22°C, 51% RH	6dB Bandwidth	9 kHz
Test Date	2024/11/29	Test Condition	LAN port (1Gbps)
Tested by	Guanwei Liao	Test Site	W01-CE

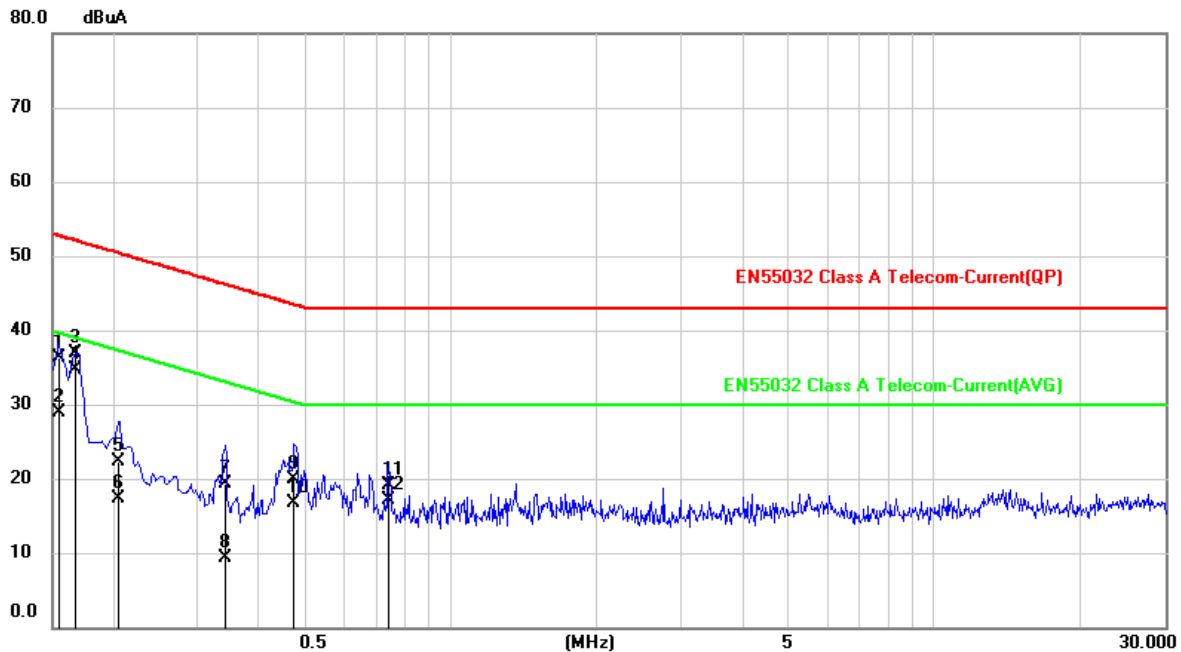

No.	Frequency (MHz)	Reading Level (dBμA)	Correct Factor (dB)	Measurement (dBμA)	Limit (dBμA)	Margin (dB)	Detector
1	0.1547	25.70	10.55	36.25	52.74	-16.49	QP
2	0.1547	18.29	10.55	28.84	39.74	-10.90	AVG
3	0.1669	26.35	10.51	36.86	52.11	-15.25	QP
4	0.1669	24.26	10.51	34.77	39.11	-4.34	AVG
5	0.2046	11.89	10.39	22.28	50.42	-28.14	QP
6	0.2046	6.89	10.39	17.28	37.42	-20.14	AVG
7	0.3419	8.98	10.33	19.31	46.16	-26.85	QP
8	0.3419	-1.00	10.33	9.33	33.16	-23.83	AVG
9	0.4757	9.66	10.32	19.98	43.41	-23.43	QP
10	0.4757	6.39	10.32	16.71	30.41	-13.70	AVG
11	0.7468	8.72	10.32	19.04	43.00	-23.96	QP
12	0.7468	6.88	10.32	17.20	30.00	-12.80	AVG

Remark: 1. QP = Quasi Peak, AVG = Average
 2. Correct Factor = ISN Factor (or Current Probe Factor) + Cable Loss + Transient Limiter (If use)
 3. Measurement Value = Reading Level + Correct Factor
 4. Margin Level = Measurement Value - Limit Value



Test Voltage	230Vac, 50Hz	Frequency Range	0.15 ~ 30 MHz
Environmental Conditions	22°C, 51% RH	6dB Bandwidth	9 kHz
Test Date	2024/11/29	Test Condition	LAN port (2.5Gbps)
Tested by	Guanwei Liao	Test Site	W01-CE

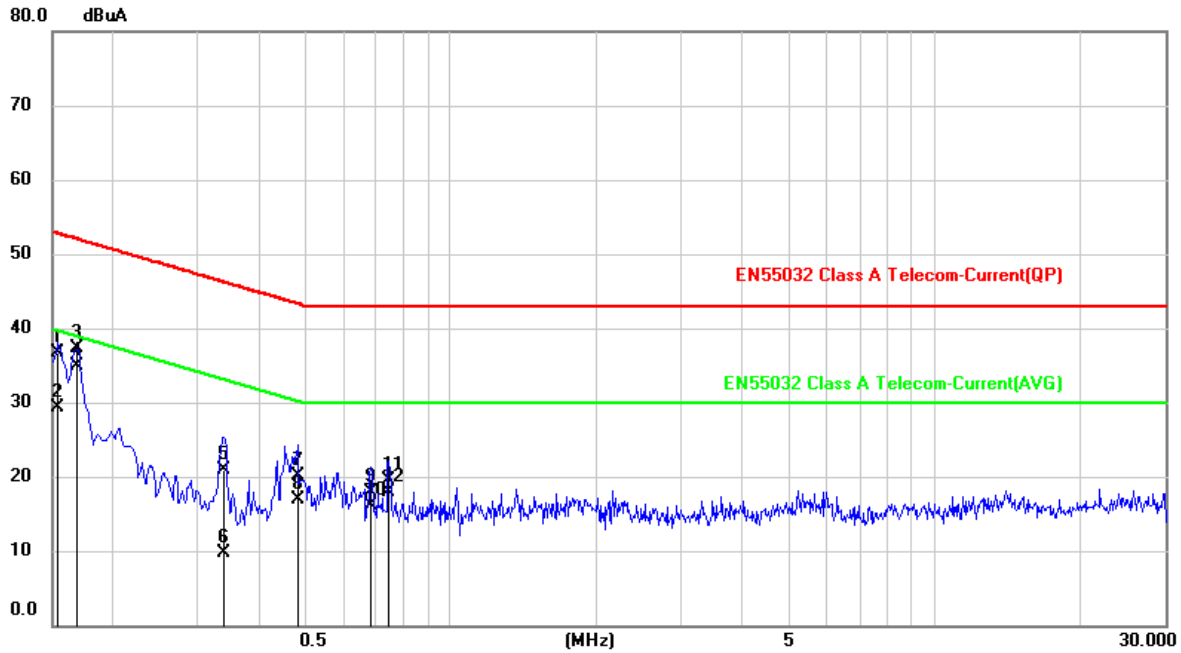

No.	Frequency (MHz)	Reading Level (dBμA)	Correct Factor (dB)	Measurement (dBμA)	Limit (dBμA)	Margin (dB)	Detector
1	0.1538	26.13	10.56	36.69	52.79	-16.10	QP
2	0.1538	18.70	10.56	29.26	39.79	-10.53	AVG
3	0.1677	26.77	10.51	37.28	52.07	-14.79	QP
4	0.1677	24.32	10.51	34.83	39.07	-4.24	AVG
5	0.3399	10.54	10.33	20.87	46.21	-25.34	QP
6	0.3399	-0.66	10.33	9.67	33.21	-23.54	AVG
7	0.4793	9.85	10.32	20.17	43.35	-23.18	QP
8	0.4793	6.52	10.32	16.84	30.35	-13.51	AVG
9	0.6821	7.56	10.32	17.88	43.00	-25.12	QP
10	0.6821	5.79	10.32	16.11	30.00	-13.89	AVG
11	0.7454	9.14	10.32	19.46	43.00	-23.54	QP
12	0.7454	7.57	10.32	17.89	30.00	-12.11	AVG

Remark: 1. QP = Quasi Peak, AVG = Average
 2. Correct Factor = ISN Factor (or Current Probe Factor) + Cable Loss + Transient Limiter (If use)
 3. Measurement Value = Reading Level + Correct Factor
 4. Margin Level = Measurement Value - Limit Value

4.2.7 Photographs of Measurement Configuration

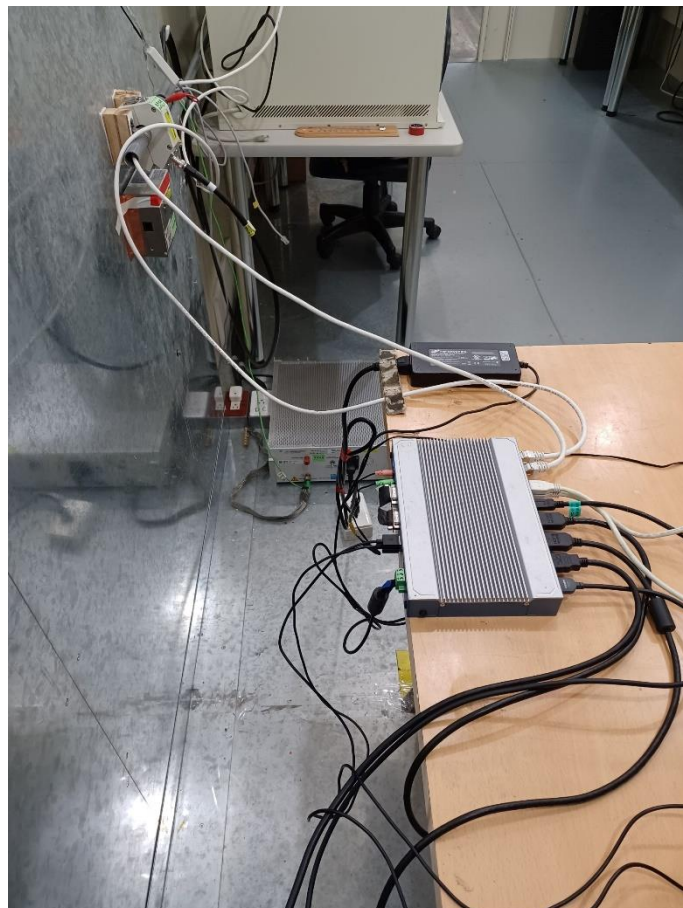
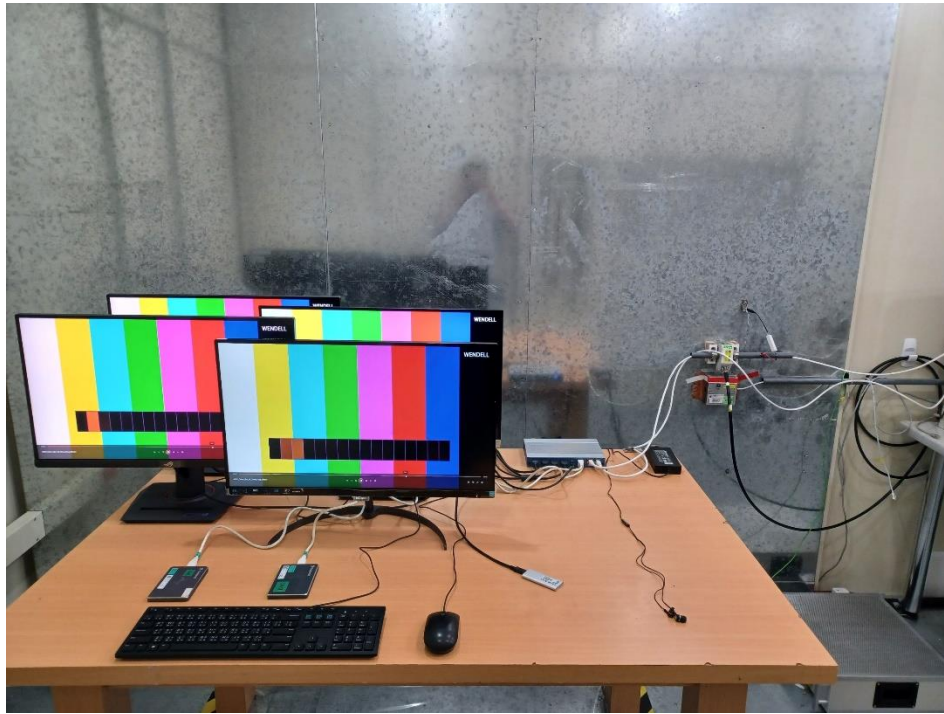

4.3 Radiated Emission Measurement

4.3.1 Limit of Radiated Emission Measurement

According to EN 55032 table1 - Required highest frequency for radiated measurement:

Highest internal frequency (F_x)	Highest measured frequency
$F_x \leq 108$ MHz	1 GHz
108 MHz $< F_x \leq 500$ MHz	2 GHz
500 MHz $< F_x \leq 1$ GHz	5 GHz
$F_x > 1$ GHz	$5 \times F_x$ up to a maximum of 6 GHz

Remark:

1. F_x : highest fundamental frequency generated or used within the EUT or highest frequency at which it operates.
2. Where F_x is unknown, the radiated emission measurements shall be performed up to 6 GHz.

Class A equipment:

Requirements for radiated emissions at frequencies up to 1 GHz for Class A equipment			
Frequency (MHz)	Measurement		Class A limits dB(μ V/m)
	Distance (m)	Detector type/ bandwidth	OATS/SAC
30 to 230	10	Quasi Peak / 120 kHz	40
230 to 1000			47
30 to 230	3		50
230 to 1000			57

Requirements for radiated emissions at frequencies above 1 GHz for Class A equipment			
Frequency (MHz)	Measurement		Class A limits dB(μ V/m)
	Distance (m)	Detector type/ bandwidth	FSOATS
1000 to 3000	3	Average / 1 MHz	56
3000 to 6000			60
1000 to 3000		Peak / 1 MHz	76
3000 to 6000			80

Class B equipment:

Requirements for radiated emissions at frequencies up to 1 GHz for Class B equipment			
Frequency (MHz)	Measurement		Class B limits dB(μ V/m)
	Distance (m)	Detector type/ bandwidth	OATS/SAC
30 to 230	10	Quasi Peak / 120 kHz	30
230 to 1000			37
30 to 230	3		40
230 to 1000			47

Requirements for radiated emissions at frequencies above 1 GHz for Class B equipment			
Frequency (MHz)	Measurement		Class B limits dB(μ V/m)
	Distance (m)	Detector type/ bandwidth	FSOATS
1000 to 3000	3	Average / 1 MHz	50
3000 to 6000			54
1000 to 3000		Peak / 1 MHz	70
3000 to 6000			74

- Note:**
1. The lower limit shall apply at the transition frequency.
 2. Detector function in the form: PK = Peak, QP = Quasi Peak, AVG = Average
 3. The result calculated as following:
 Measurement Value = Reading Level + Correct Factor
 Correct Factor = Antenna Factor + Cable Loss (Antenna to Pre-Amplifier) -
 Pre-Amplifier Gain + Cable Loss (Pre-Amplifier to Receiver)
 Margin Level = Measurement Value - Limit Value

At the same test procedures, due to the limits of EN 55032: 2015 + A11: 2020 are severe than EN 55032: 2015 + A1: 2020, When the requirements of EN 55032: 2015 + A11: 2020 are satisfied, the requirement of EN 55032: 2015 + A1: 2020 could be considered satisfied.

At the same test procedures, due to the limits of CISPR 32: 2015 + COR1: 2016 are severe than CISPR 32: 2015 + A1: 2019, When the requirements of CISPR 32: 2015 + COR1: 2016 are satisfied, the requirement of CISPR 32: 2015 + A1: 2019 could be considered satisfied.



4.3.2 Measurement Instrument

Test Site: W08-966-1					
Item	Equipment	Manufacturer	Model	Meter No.	Calibration Date
1	Horn Antenna	Schwarzbeck	BBHA 9120D	CT-9-031	Jul. 29, 2024
2	Horn Antenna	Schwarzbeck	BBHA 9170	CT-9-032	Aug. 15, 2024
3	TRILOG Broadband Antenna with 6 dB Attenuator	Schwarzbeck & MVE	VULB 9168 & MVE2251-06	CT-1-096-1	May 06, 2024
4	Spectrum Analyzer	Agilent	E4407B	CT-1-003(1)	Aug. 08, 2024
5	EXA Signal Analyzer	Keysight	N9010A	CT-1-093	Aug. 18, 2024
6	EMI Test Receiver	Keysight	N9038A	CT-9-007	Aug. 09, 2024
7	Preamplifier	EM	EMC330	CT-9-024	Aug. 08, 2024
8	Preamplifier	SGH & MCL	SGH118 & BW-S15W2+	CT-9-071	Aug. 08, 2024
9	Preamplifier	EMCI	EMC184045SE	CT-9-013	Aug. 16, 2024
10	Test Cable	EMCI	EMCCFD400-NM-NM-1000	CT-1-132	Aug. 10, 2024
11	Test Cable	PEWC	CFD400NL-LW-NM-NM-3000	CT-1-141	Aug. 10, 2024
12	Test Cable	EMCI	EMCCFD400-NM-NM-15000	CT-1-133	Aug. 10, 2024
13	Test Cable	EMCI	EMC104-SM-35M-600	CT-1-134	Aug. 09, 2024
14	Test Cable	MVE	280280.LL266.1400	CT-9-106	Aug. 09, 2024
15	Test Cable	EMCI	EMC102-KM-KM-600	CT-1-136	Aug. 21, 2024
16	Measurement Software	EZ-EMC	Ver :WD-03A1-1	CT-3-012	No calibration request

Note: 1. The calibration interval of the above test instruments is 12 months.

4.3.3 Measurement Procedure

- a. The table-top equipment under test was placed on the top of a turntable 0.8 meter above the ground at 3 m 966 chamber. The floor-standing equipment under test was placed insulation support unit from the horizontal ground plane. The turntable was rotated 360 degrees to determine the position of the highest radiation emissions.
- b. The height of the antenna shall vary between 1 m to 4 m. Both vertical and horizontal polarizations of the antenna were set to make the measurement.
- c. The loads and/or devices simulating typical operating conditions shall be connected to at least one of each type of interface port of the equipment under test. If loading (or terminating) with a device of actual usage is not feasible, the port should be loaded with a simulator. Where these options are not practical the port shall be loaded by the application of a typical impedance considering both the common and differential modes.
- d. The initial step in collecting radiated emission data is a spectrum mode scanning the measurement frequency range.

Below 1GHz:

Reading in which marked as QP means measurements by using receiver mode with detector setting in RBW = 120 kHz.

If the spectrum mode measured peak value compliance with and lower than QP Limit, the equipment under test shall be deemed to meet QP Limits.

Above 1GHz:

Reading in which marked as Peak & AVG means measurements by using spectrum mode with setting in RBW = 1 MHz.

If the spectrum mode measured value compliance with the Peak Limits and lower than AVG Limits, the equipment under test shall be deemed to meet both Peak and AVG Limits.

- e. Emission frequency and amplitude were recorded, recording at least six highest emissions. The equipment under test and cable configuration of the above highest emission amplitude were recorded.

4.3.4 Deviation from Standard

No deviation

4.3.5 Measurement Configuration

< Radiated Emissions Frequency: 30 MHz to 1000 MHz >

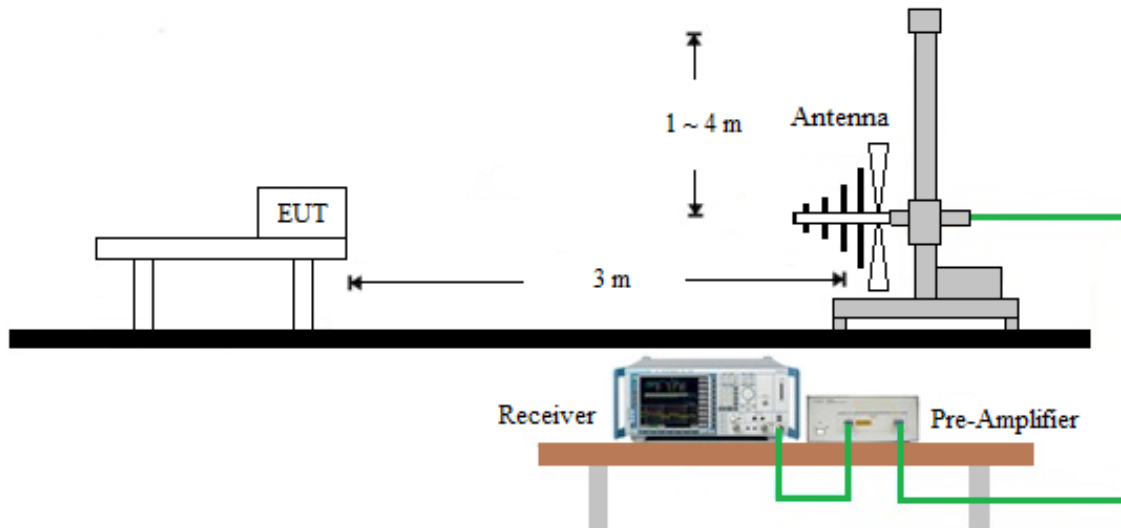

< Radiated Emissions Frequency: above 1GHz >

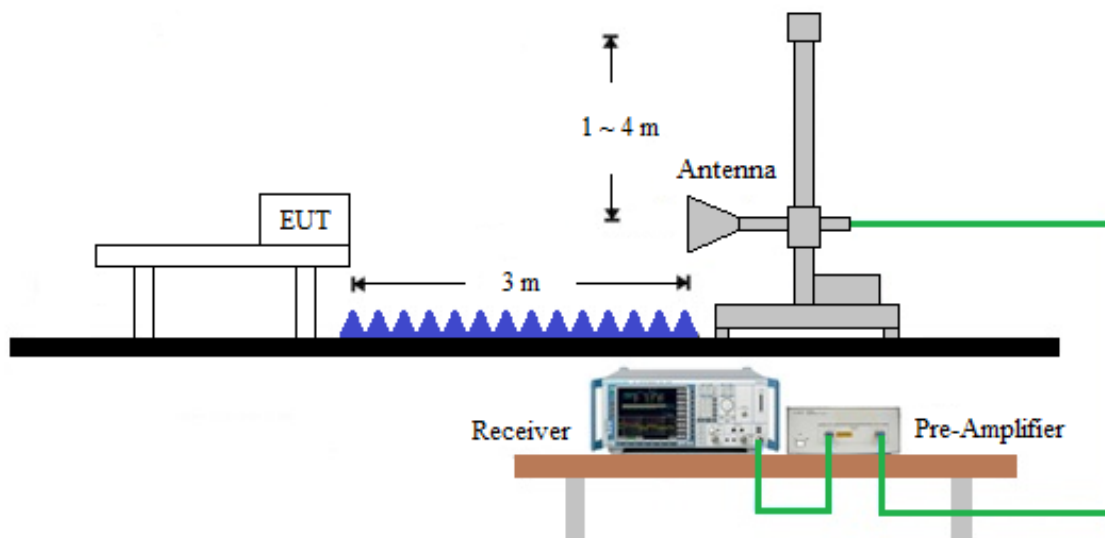

Note:

- (1) Please refer to the 4.3.7 for the actual test configuration.
- (2) Detector function in the form: PK = Peak, QP = Quasi Peak, AVG = Average
- (3) The test result calculated as following:
 Measurement Value = Reading Level + Correct Factor
 Correct Factor = Antenna Factor + Cable Loss – Pre-Amplifier Gain (if use)
 Margin Level = Measurement Value - Limit Value

< EUT placement top view and measurement distance >

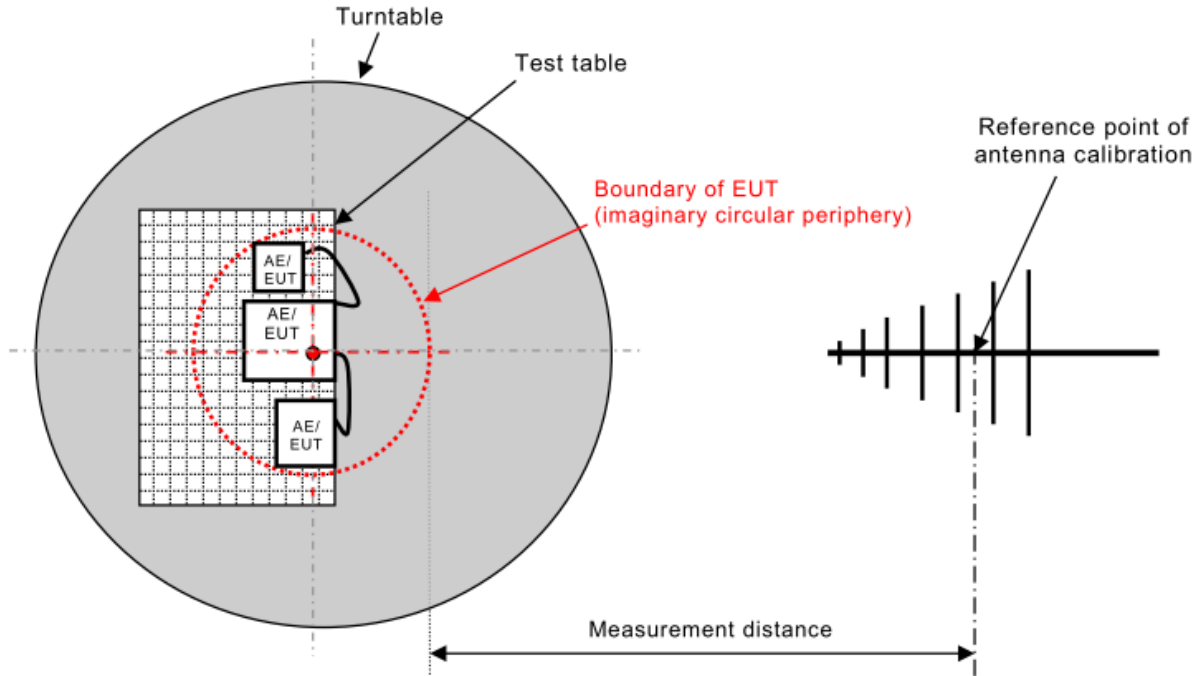

< Boundary of EUT, Local AE and associated cabling >

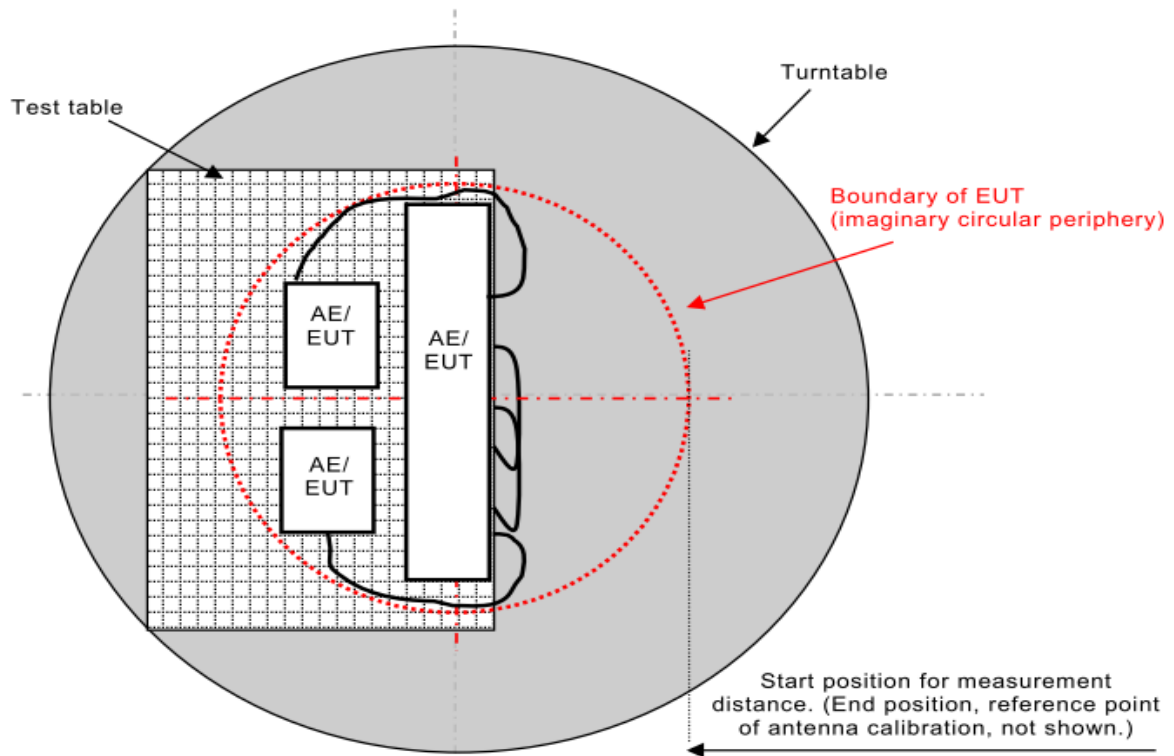

< Table-Top equipment under test >

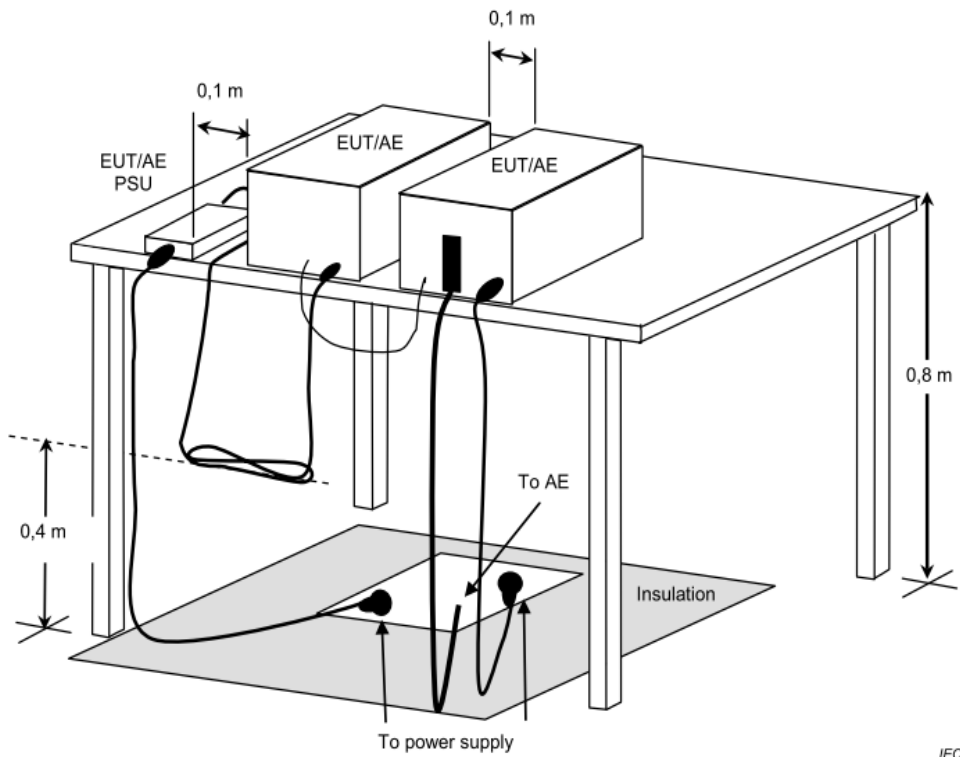

< Floor-Standing equipment under test >

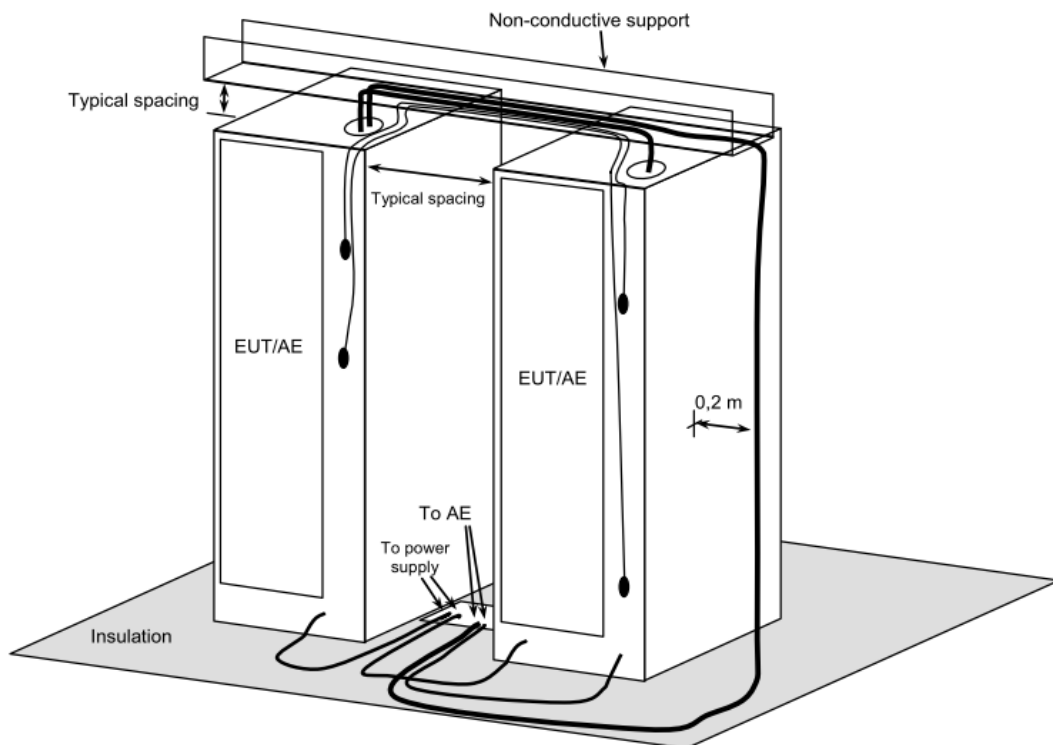

Note: Please refer to the 4.3.7 for the actual test configuration.



4.3.6 Measurement Result

Test Voltage	230Vac, 50Hz	Frequency Range	30 ~ 1000 MHz
Environmental Conditions	22°C, 50% RH	6dB Bandwidth	120 kHz
Test Date	2024/11/27	Test Distance	3m
Tested by	Karwin Kao	Polarization	Vertical
Test Site	W08-966-1		

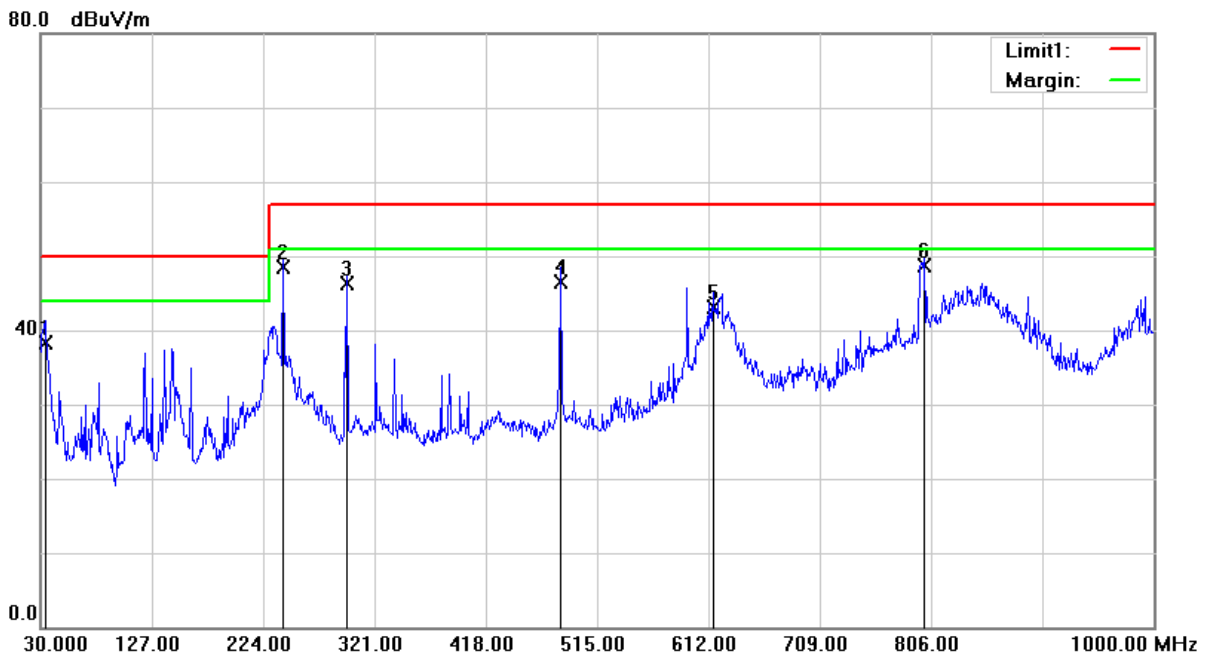

No.	Frequency (MHz)	Reading Level (dBμV)	Correct Factor (dB/m)	Measurement (dBμV/m)	Limit (dBμV/m)	Margin (dB)	Table Degree (degree)	Antenna Height (cm)	Detector
1	33.8800	49.35	-11.11	38.24	50.00	-11.76	218	100	QP
2	241.4600	59.18	-10.72	48.46	57.00	-8.54	351	200	QP
3	296.7500	54.69	-8.45	46.24	57.00	-10.76	19	200	QP
4	482.9900	49.78	-3.29	46.49	57.00	-10.51	279	100	QP
5	615.8800	42.82	0.36	43.18	57.00	-13.82	334	200	QP
6	800.1800	44.51	4.11	48.62	57.00	-8.38	16	200	QP

Remark: 1. QP = Quasi Peak
 2. Correct Factor = Antenna Factor + Cable Loss (Antenna to Pre-Amplifier) – Pre-Amplifier Gain + Cable Loss (Pre-Amplifier to Receiver)
 3. Measurement Value = Reading Level + Correct Factor
 4. Margin Level = Measurement Value – Limit Value



Test Voltage	230Vac, 50Hz	Frequency Range	30 ~ 1000 MHz
Environmental Conditions	22°C, 50% RH	6dB Bandwidth	120 kHz
Test Date	2024/11/27	Test Distance	3m
Tested by	Karwin Kao	Polarization	Horizontal
Test Site	W08-966-1		

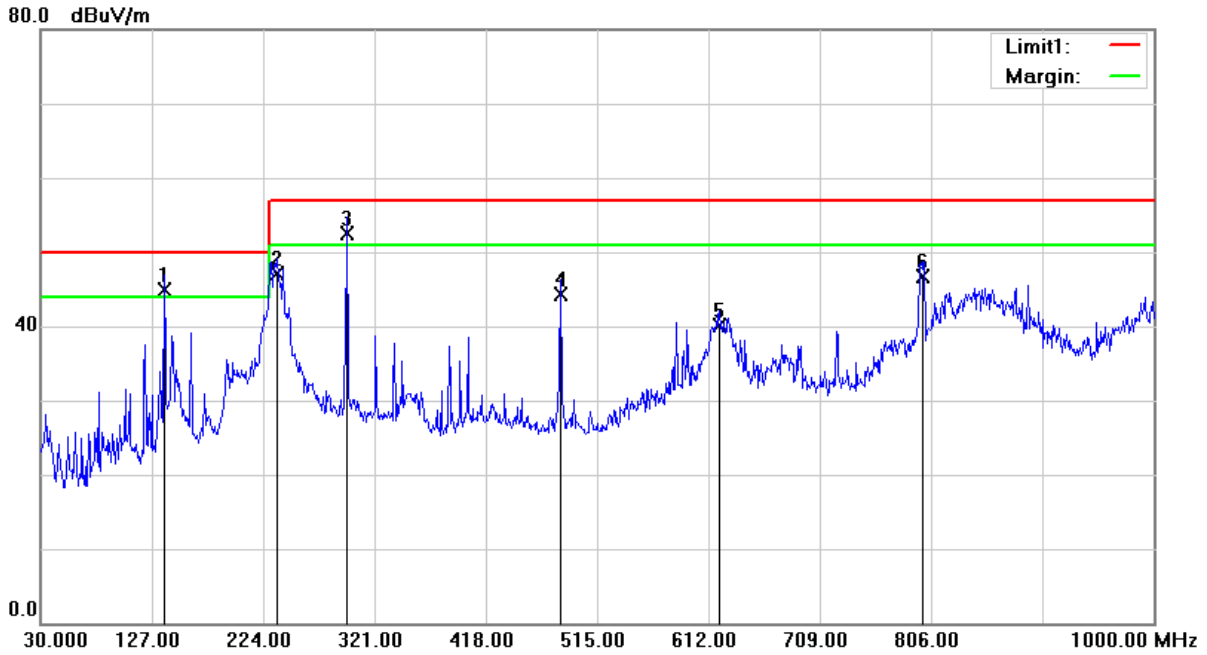

No.	Frequency (MHz)	Reading Level (dBμV)	Correct Factor (dB/m)	Measurement (dBμV/m)	Limit (dBμV/m)	Margin (dB)	Table Degree (degree)	Antenna Height (cm)	Detector
1	137.6700	54.97	-10.15	44.82	50.00	-5.18	272	200	QP
2	236.6100	58.25	-11.17	47.08	57.00	-9.92	80	100	QP
3	296.7500	61.05	-8.45	52.60	57.00	-4.40	144	100	QP
4	482.9900	47.58	-3.29	44.29	57.00	-12.71	222	200	QP
5	621.7000	39.57	0.56	40.13	57.00	-16.87	360	100	QP
6	798.2400	42.66	4.10	46.76	57.00	-10.24	134	100	QP

Remark: 1. QP = Quasi Peak
 2. Correct Factor = Antenna Factor + Cable Loss (Antenna to Pre-Amplifier) – Pre-Amplifier Gain + Cable Loss (Pre-Amplifier to Receiver)
 3. Measurement Value = Reading Level + Correct Factor
 4. Margin Level = Measurement Value – Limit Value



Test Voltage	230Vac, 50Hz	Frequency Range	1 ~ 6 GHz
Environmental Conditions	22°C, 50% RH	6dB Bandwidth	1MHz
Test Date	2024/11/27	Test Distance	3m
Tested by	Karwin Kao	Polarization	Vertical
Test Site	W08-966-1		

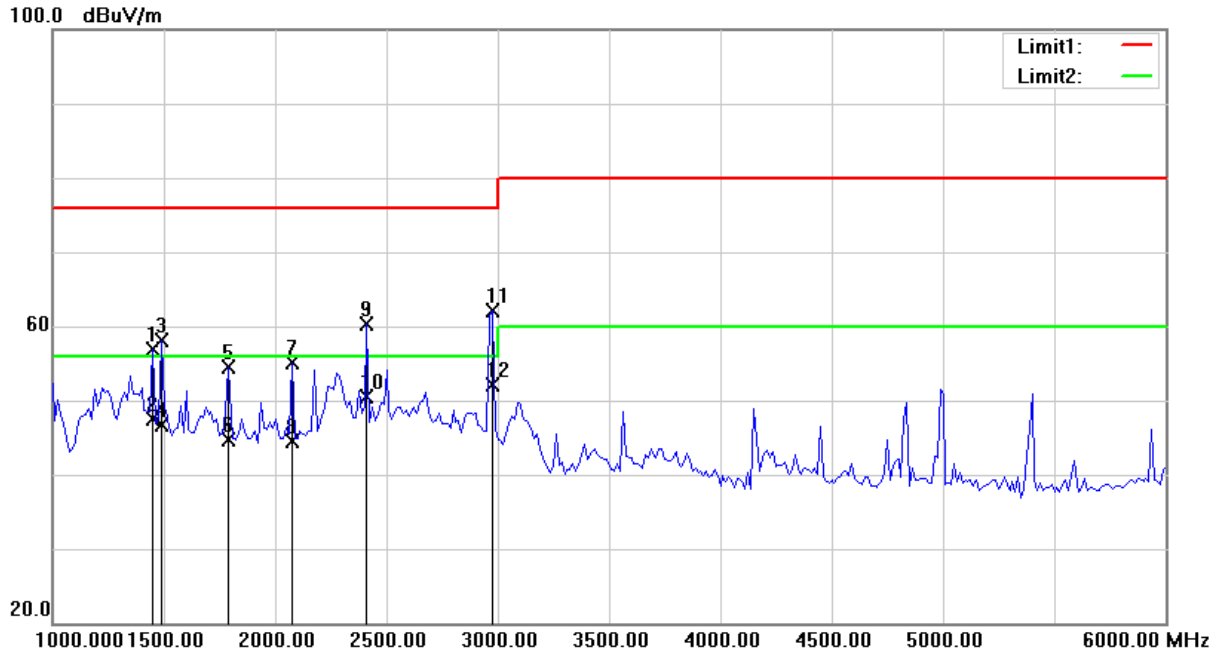

No.	Frequency (MHz)	Reading Level (dBμV)	Correct Factor (dB/m)	Measurement (dBμV/m)	Limit (dBμV/m)	Margin (dB)	Table Degree (degree)	Antenna Height (cm)	Detector
1	1450.000	75.33	-18.39	56.94	76.00	-19.06	152	100	peak
2	1450.000	65.80	-18.39	47.41	56.00	-8.59	152	100	AVG
3	1487.500	76.81	-18.70	58.11	76.00	-17.89	33	100	peak
4	1487.500	65.46	-18.70	46.76	56.00	-9.24	33	100	AVG
5	1787.500	73.00	-18.55	54.45	76.00	-21.55	177	100	peak
6	1787.500	63.32	-18.55	44.77	56.00	-11.23	177	100	AVG
7	2075.000	71.75	-16.58	55.17	76.00	-20.83	133	100	peak
8	2075.000	61.09	-16.58	44.51	56.00	-11.49	133	100	AVG
9	2412.500	75.46	-15.24	60.22	76.00	-15.78	218	100	peak
10	2412.500	65.78	-15.24	50.54	56.00	-5.46	218	100	AVG
11	2975.000	75.64	-13.47	62.17	76.00	-13.83	158	100	peak
12	2975.000	65.49	-13.47	52.02	56.00	-3.98	158	100	AVG

Remark: 1. peak = Peak, AVG = Average
 2. Correct Factor = Antenna Factor + Cable Loss (Antenna to Pre-Amplifier) – Pre-Amplifier Gain + Cable Loss (Pre-Amplifier to Receiver)
 3. Measurement Value = Reading Level + Correct Factor
 4. Margin Level = Measurement Value – Limit Value



Test Voltage	230Vac, 50Hz	Frequency Range	1 ~ 6 GHz
Environmental Conditions	22°C, 50% RH	6dB Bandwidth	1MHz
Test Date	2024/11/27	Test Distance	3m
Tested by	Karwin Kao	Polarization	Horizontal
Test Site	W08-966-1		

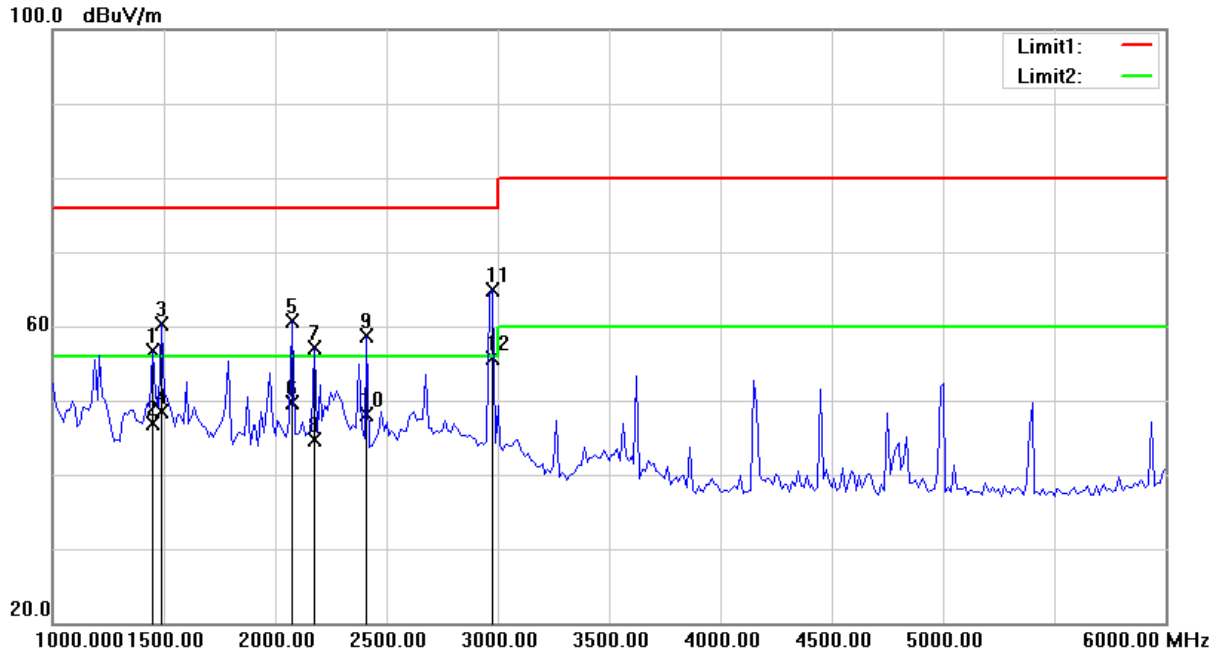

No.	Frequency (MHz)	Reading Level (dBμV)	Correct Factor (dB/m)	Measurement (dBμV/m)	Limit (dBμV/m)	Margin (dB)	Table Degree (degree)	Antenna Height (cm)	Detector
1	1450.000	75.18	-18.39	56.79	76.00	-19.21	254	100	peak
2	1450.000	65.21	-18.39	46.82	56.00	-9.18	254	100	AVG
3	1487.500	78.96	-18.70	60.26	76.00	-15.74	8	100	peak
4	1487.500	67.21	-18.70	48.51	56.00	-7.49	8	100	AVG
5	2075.000	77.19	-16.58	60.61	76.00	-15.39	345	100	peak
6	2075.000	66.29	-16.58	49.71	56.00	-6.29	345	100	AVG
7	2175.000	72.65	-15.47	57.18	76.00	-18.82	225	100	peak
8	2175.000	60.11	-15.47	44.64	56.00	-11.36	225	100	AVG
9	2412.500	73.97	-15.24	58.73	76.00	-17.27	194	100	peak
10	2412.500	63.29	-15.24	48.05	56.00	-7.95	194	100	AVG
11	2975.000	78.42	-13.47	64.95	76.00	-11.05	327	100	peak
12	2975.000	69.24	-13.47	55.77	56.00	-0.23	327	100	AVG

Remark: 1. peak = Peak, AVG = Average
 2. Correct Factor = Antenna Factor + Cable Loss (Antenna to Pre-Amplifier) – Pre-Amplifier Gain + Cable Loss (Pre-Amplifier to Receiver)
 3. Measurement Value = Reading Level + Correct Factor
 4. Margin Level = Measurement Value – Limit Value

4.3.7 Photographs of Measurement Configuration

Frequency Range: 30 MHz ~ 1 GHz



Frequency Range: Above 1 GHz



4.4 Harmonic Current Measurement

4.4.1 Limit of Harmonic Current Measurement

Limit for Class A equipment	
Harmonic Order <i>n</i>	Max. permissible harmonics current A
Odd harmonic	
3	2.30
5	1.14
7	0.77
9	0.40
11	0.33
13	0.21
$15 \leq n \leq 39$	$0.15*(15/n)$
Even harmonic	
2	1.08
4	0.43
6	0.30
$8 \leq n \leq 40$	$0.23*(8/n)$

Limit for Class D equipment		
Harmonic Order <i>n</i>	Max. permissible harmonics current per watt mA/W	Max. permissible harmonics current A
Odd Harmonic only		
3	3.4	2.30
5	1.9	1.14
7	1.0	0.77
9	0.5	0.40
11	0.35	0.33
13	0.30	0.21
$15 \leq n \leq 39$	$3.85/n$	$0.15*(15/n)$

- Note:** 1. Class A and Class D are classified according to item section 5 of EN IEC 61000-3-2.
 2. According to section 7 of EN IEC 61000-3-2, the above limits for all equipment except for Class B or C equipment and no limits apply for equipment with a rated power of 75W or less.

4.4.2 Measurement Instrument

Item	Equipment	Manufacturer	Model	Meter No.	Calibration Date
1	Harmonic & Flicker Analyzer	EMC PARTNER	HAR-1000-1P	CT-1-090(1)	Oct. 17, 2024
2	Power Source	APC	AFV-P-5000B	CT-1-210	Oct. 17, 2024

- Note:** 1. The calibration interval of the above test instruments is 12 months.

4.4.3 Measurement Procedure

The table-top equipment under test was placed on the top of a wooden table 0.8 meter above the ground and operated to produce the maximum harmonic under normal operating conditions for each successive harmonic component in turn. The floor-standing equipment under test was placed insulation support unit from the horizontal ground plane.

The classification of equipment is according to section 5 of EN IEC 61000-3-2.

The equipment is classified as follows:

Class A:

Equipment not specified as belonging to Class B, C or D shall be considered as Class A equipment.

Some example of Class A equipment are:

- Balanced three-phase equipment;
- Household appliances, excluding those specified as belonging to Class B, C or D;
- Vacuum cleaners;
- High pressure cleaners;
- Tools, excluding portable tools;
- Independent phase control dimmers;
- Audio equipment;
- Professional luminaires for stage lighting and studios.

Class B:

- Portable tools;
- Arc welding equipment which is not professional equipment.

Class C:

- Lighting equipment;
- Integrated lamps, integrated luminaires, non-integrated luminaires, separate lighting control gear;
- Lighting part of multi-function equipment where one the primary function of this is illumination;
- Ultraviolet (UV) and infrared (IR) radiation equipment;
- Illuminated advertising signs;
- Independent dimmers, other than phase control type, for lighting equipment;
- DLT control device.

Class D:

Equipment having a specified power less than or equal to 600W, of the following types:

- Personal computers and personal computer monitors;
- Television receivers;
- Refrigerators and freezers having one or more variable-speed drives to control compressor motor(s).

4.4.4 Deviation from Standard

No deviation

4.4.5 Measurement Configuration

< Table-Top equipment under test >

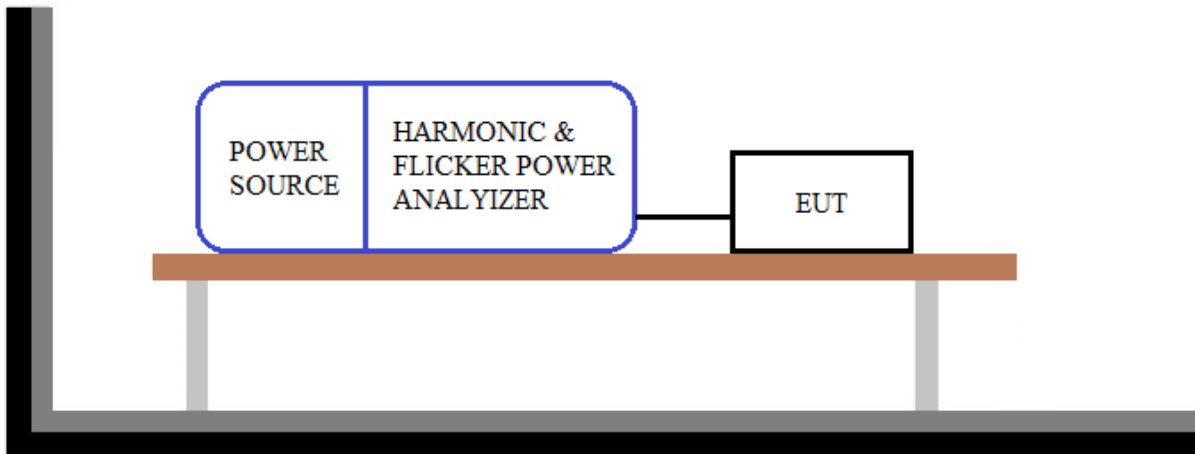

< Floor-Standing equipment under test >

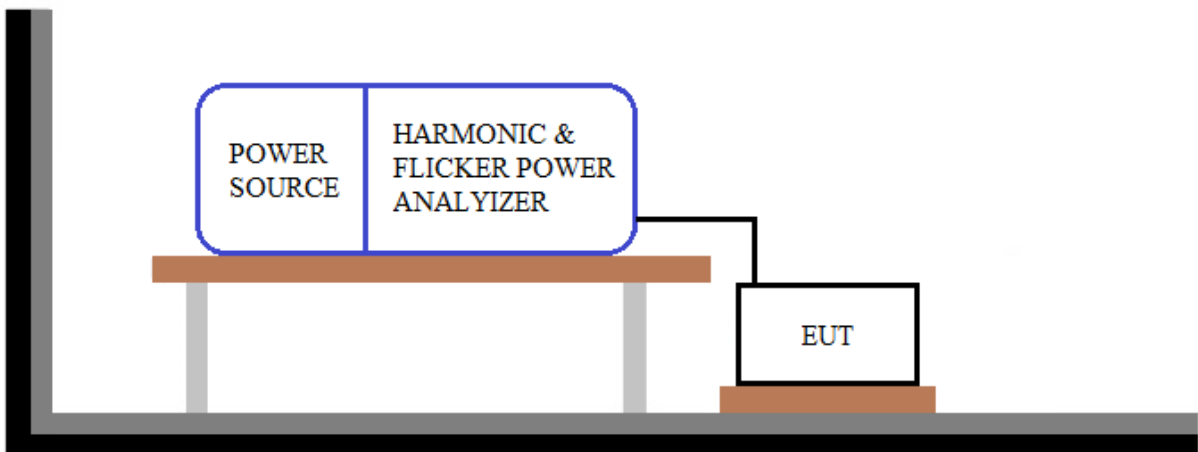



4.4.6 Measurement Result

Supply Voltage / Ampere	229.7 V _{rms} / 0.215 A _{rms}	Test Date	2024/10/21
Test Duration	5 min	Power Consumption	40.37W
Power Frequency	50.013Hz	Power Factor	0.818
Environmental Conditions	22 °C, 52% RH	Tested by	Eric Hsieh

Note:

1. Limits are not specified for equipment with a rated power of 75W or less.
2. According to EN IEC 61000-3-2 the manufacturer shall specify the power of the apparatus. This value shall be used for establishing limits. The specified power shall be within +/-10% of the measured power.

4.4.7 Photographs of Measurement Configuration

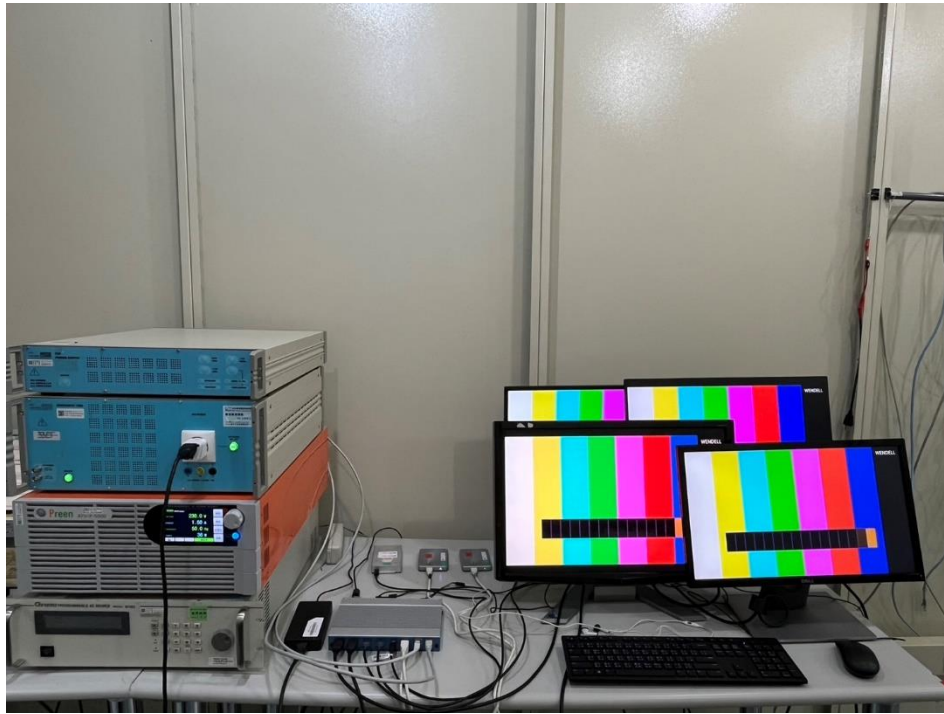

4.5 Voltage Fluctuations and Flicker Measurement

4.5.1 Limit for Voltage Functions and Flicker Measurement

Tests Item	Limits	Remark
	IEC/EN 61000-3-3	
P_{st}	1.0, $T_p=10$ min.	P_{st} means short-term flicker indicator.
P_{lt}	0.65, $T_p=2$ hr.	P_{lt} means long-term flicker indicator.
d_c (%)	3.3%	d_c means relative steady-state voltage change.
d_{max} (%)	4%	d_{max} means maximum relative voltage change.
T_{dt} (ms)	500 ms	T_{dt} means maximum time that $d(t)$ exceeds 3.3 %.

4.5.2 Measurement Instrument

Item	Equipment	Manufacturer	Model	Meter No.	Calibration Date
1	Harmonic & Flicker Analyzer	EMC PARTNER	HAR-1000-1P	CT-1-090(1)	Oct. 17, 2024
2	Power Source	APC	AFV-P-5000B	CT-1-210	Oct. 17, 2024

Note: 1. The calibration interval of the above test instruments is 12 months.

4.5.3 Measurement Procedure

The table-top equipment under test was placed on the top of a wooden table 0.8 meter above the ground and operated to produce the most unfavorable sequence of voltage changes under normal operating condition. The floor-standing equipment under test was placed insulation support unit from the horizontal ground plane.

During the flick measurement, the measure time shall include that part of whole operation cycle in which the EUT produce the most unfavorable sequence of voltage changes. The observation period for short-term flicker indicator is 10 min and the observation period for long-term flicker indicator is 2 hours.

4.5.4 Deviation from Standard

No deviation

4.5.5 Measurement Configuration

< Table-Top equipment under test >

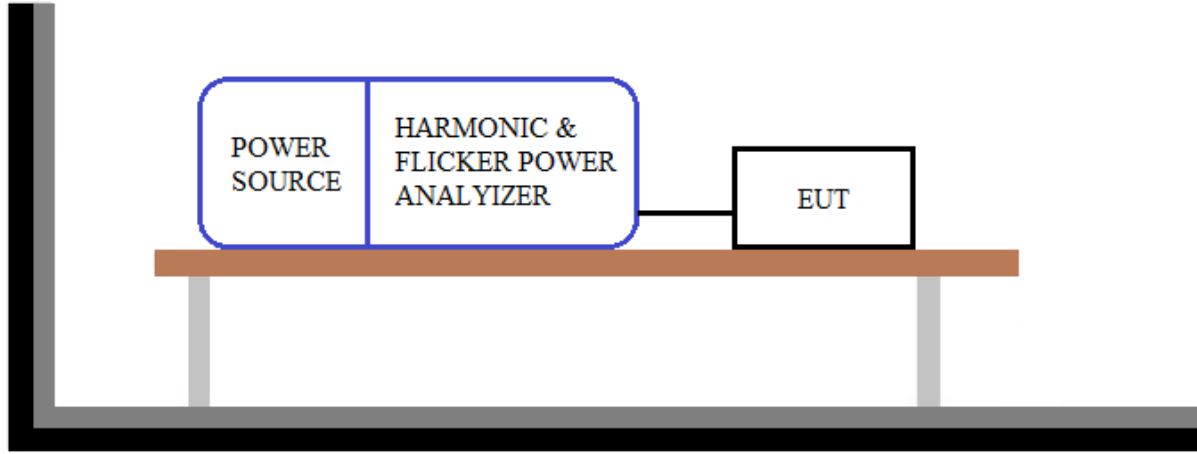

< Floor-Standing equipment under test >

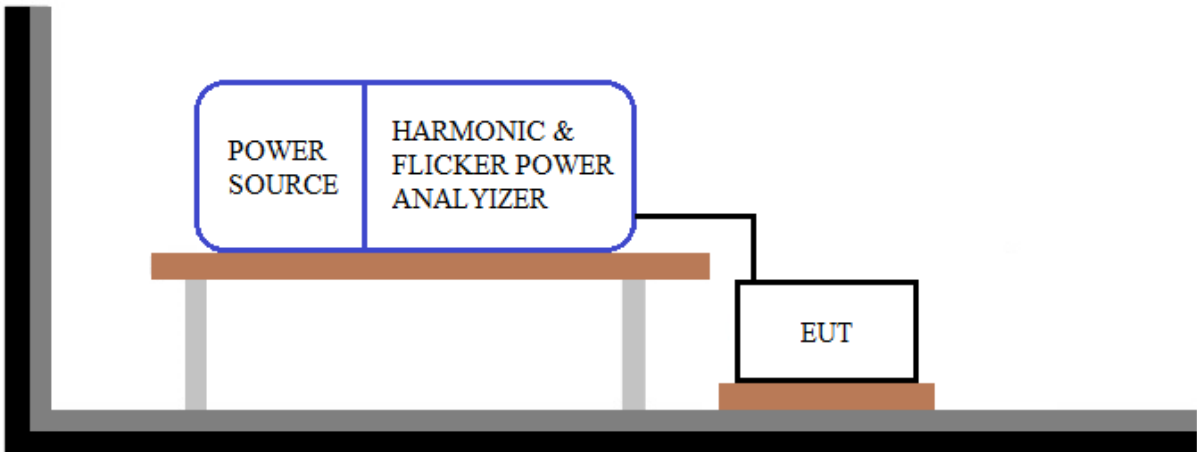



4.5.6 Measurement Result

Supply Voltage / Ampere	229.5 Vrms / 0.203 Arms	Test Date	2024/10/21
Observation (Tp)	30 min	Environmental Conditions	22 °C, 52% RH
Power Frequency	50.000Hz	Tested by	Eric Hsieh

Test Parameter	Measurement Value	Test Limit	Remarks
P_{st}	0.07	1.00	Pass
P_{lt}	0.07	0.65	Pass
T_{dt} (ms)	0.00	500	Pass
d_{max} (%)	0.00	4%	Pass
d_c (%)	0.02	3.3%	Pass

- Note:**
1. P_{st} means short-term flicker indicator.
 2. P_{lt} means long-term flicker indicator.
 3. T_{dt} means maximum time that dt exceeds 3.3 %.
 4. d_{max} means maximum relative voltage change.
 5. d_c means relative steady-state voltage change.

4.5.7 Photographs of Measurement Configuration

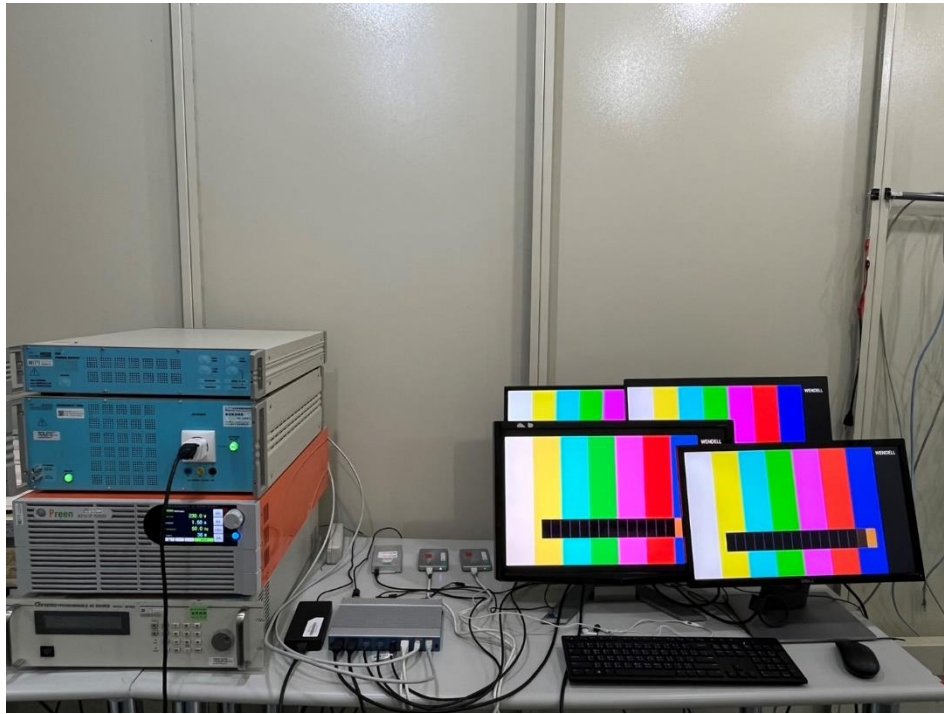

5 Immunity Test

5.1 Standard Description

Product standard	EN 55035	
Basic Standard and Performance Criterion required	IEC 61000-4-2 (ESD)	Contact discharge: ± 4 kV, Air discharge: ± 8 kV Performance Criterion B
	IEC 61000-4-3 (RS)	Field Strength: 3 V/m, Test Signal: 80% AM with 1 kHz sine wave Frequency Range: 80 M ~ 1000 MHz, 1800 MHz, 2600 MHz, 3500 MHz, 5000 MHz for spot test Performance Criterion A
	IEC 61000-4-4 (EFT)	AC Main Power Port: ± 1 kV DC Network Power Port (cable length > 3m): ± 0.5 kV Analogue/Digital Data Port (cable length > 3m): ± 0.5 kV Repetition Frequency: 5 kHz Performance Criterion B
	IEC 61000-4-5 (Surge)	AC Main Power Port - Line to Line: ± 1 kV, Line to Ground: ± 2 kV DC Network Power Port (cable length > 3m) - Line to Ground: ± 0.5 kV Performance Criteria B Analogue/Digital Data Port (unshielded symmetrical): Line to Ground Apply where primary protection is intended: ± 1 kV and ± 4 kV Apply where primary protection is not intended: ± 1 kV Performance Criteria C Analogue/Digital Data Ports (coaxial or shielded) - Shielded to Ground: ± 0.5 kV Performance Criteria B
	IEC 61000-4-6 (CS)	Voltage Level: 3 V, 3 ~ 1 V, 1 V Test Signal: 80% AM with 1 kHz sine wave Frequency Range: 0.15 M ~ 10 MHz, 10 M ~ 30 MHz, 30 M ~ 80 MHz Applicable to port: AC Main Power Port, DC Network Power Port (cable length > 3m) & Analogue/Digital Data Port (cable length > 3m) Performance Criterion A
	IEC 61000-4-8 (PFMF)	1 A/m, 50/60 Hz Performance Criterion A
	IEC 61000-4-11 (Dips)	Voltage Dips: >95% reduction, 0.5 cycle, Performance Criterion B 30% reduction, 25 cycle, Performance Criterion C Voltage Interruptions: >95% reduction, 250 cycle, Performance Criterion C

5.2 Performance Criteria

According to Clause 8 of EN 55035 standard, the general performance criteria as following:

Criteria A	The equipment shall continue to operate as intended without operator intervention. No degradation of performance, loss of function or change of operating state is allowed below a performance level specified by the manufacturer when the equipment is used as intended. The performance level may be replaced by a permissible loss of performance. If the minimum performance level or the permissible performance loss is not specified by the manufacturer, then either of these may be derived from the product description and documentation, and by what the user may reasonably expect from the equipment if used as intended.
Criteria B	During the application of the disturbance, degradation of performance is allowed. However, no unintended change of actual operating state or stored data is allowed to persist after the test. After the test, the equipment shall continue to operate as intended without operator intervention. No degradation of performance or loss of function is allowed, below a performance level specified by the manufacturer, when the equipment is used as intended. The performance level may be replaced by a permissible loss of performance. If the minimum performance level (or the permissible performance loss), or recovery time is not specified by the manufacturer, then either of these may be derived from the product description and documentation, and by what the user may reasonably expect from the equipment if used as intended.
Criteria C	Loss of function is allowed, provided the function is self-recoverable, or can be restored by the operation of the controls by the user in accordance with the manufacturer's instructions. A reboot or re-start operation is allowed. Information stored in non-volatile memory, or protected by a battery backup, shall not be lost.

5.3 Electrostatic Discharge Immunity Test

5.3.1 Test Specification

Standard	IEC/EN 61000-4-2
Discharge Impedance	330 ohm / 150 pF
Discharge Voltage	Air Discharge: ± 2 kV, ± 4 kV, ± 8 kV (Direct) Contact Discharge: ± 4 kV (Direct/Indirect)
Number of Discharge	Air: Minimum 10 times at each polarity Contact: Minimum 10 times at each polarity
Discharge Mode	Single Discharge
Discharge Period	1 second minimum

5.3.2 Test Instrument

Item	Equipment	Manufacturer	Model	Meter No.	Calibration Date
1	ESD Generator	TESEQ	NSG 437	CT-1-140	Jun. 15, 2024
2	ESD Generator	NoiseKen	ESS-B3011	CT-1-089	Jul. 23, 2024
3	Digital Thermo-Hygro Meter	N/A	HTC-8	CT-2-047	Jun. 06, 2023
4	Atmosphere pressure meter	TES	TES-1161	CT-5-094	Aug. 10, 2023

- Note:**
1. The calibration interval of the test instruments is 12 months.
 2. The calibration interval of thermo hygrometer/ Atmosphere pressure meter is 24 months.

5.3.3 Test Procedure

The test procedure was in accordance with IEC 61000-4-2.

The test generator necessary to perform direct and indirect application of discharge to the equipment under test in following methods:

a. Contact discharges to the conductive surface and coupling planes:

For table-top equipment under test one of the test points shall be the centre front edge of the horizontal coupling plane, which shall be subjected to at least 20 indirect discharges (10 of each polarity).

All other test points shall each receive at least 20 direct contact discharges (10 of each polarity).

All surfaces normally touched by the user should be tested. Test shall be performed at a maximum repetition rate of one discharge per second.

Vertical Coupling Plane (VCP):

The coupling plane, of dimensions 0.5 m × 0.5 m, is placed parallel to, and positioned at a distance 0.1 m from the equipment under test, with the discharge electrode touching the coupling plane. The four faces of the equipment under test will be performed with electrostatic discharge.

Horizontal Coupling Plane (HCP):

The coupling plane, of dimensions 1.6 m × 0.8 m, is placed under the equipment under test. The generator shall be positioned vertically a distance of 0.1 m from the equipment under test, with the discharge electrode touching the coupling plane. The four faces of the equipment under test will be performed with electrostatic discharge.

b. Air discharge at apertures and slots and insulating surface:

On those surfaces of the equipment under test where it is not possible to perform contact discharge testing, the equipment should be investigated to identify user accessible points where breakdown may occur. Such points are tested using the air discharge method. This investigation should be restricted to those area normally handled by the user. A minimum 20 single air discharges (10 of each polarity) shall be applied to the selected test point for each such area.

5.3.4 Deviation from Standard

No deviation

5.3.5 Test Configuration

< Table-Top equipment under test >

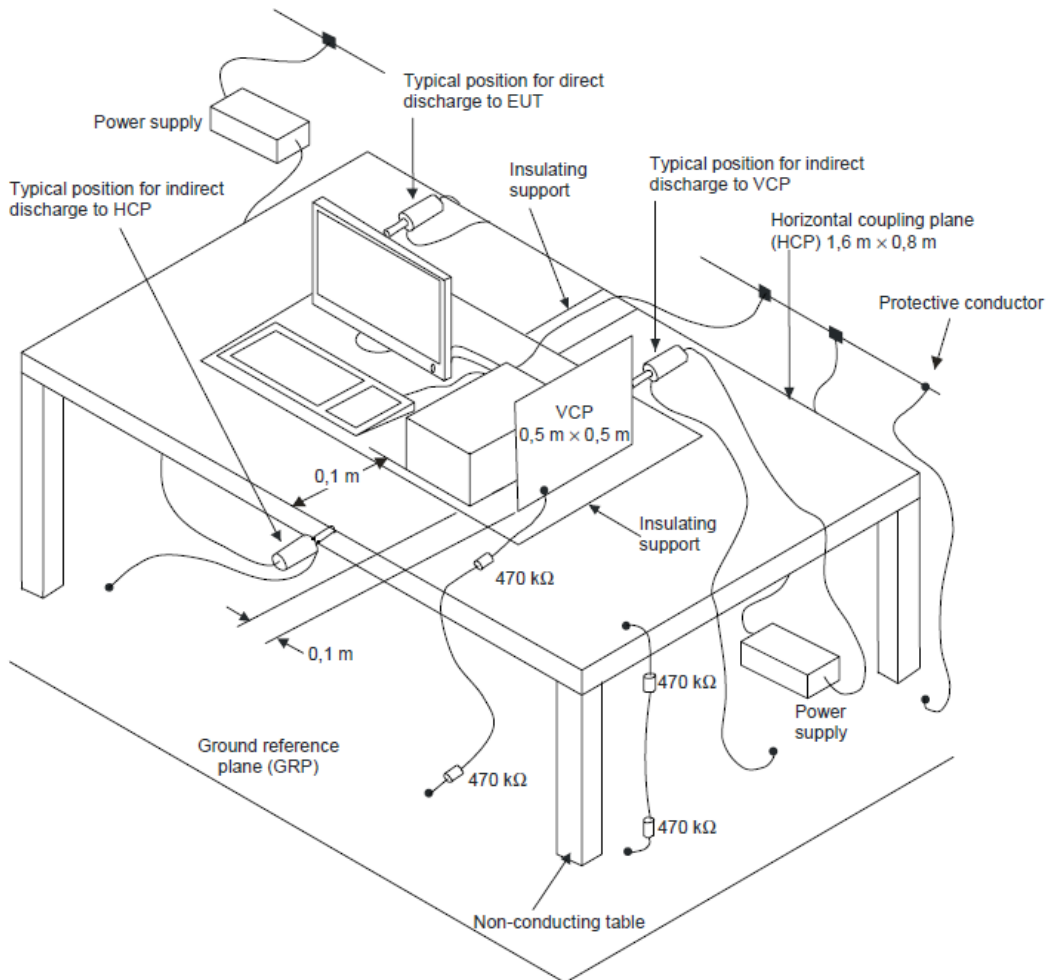

< Floor-Standing equipment under test >

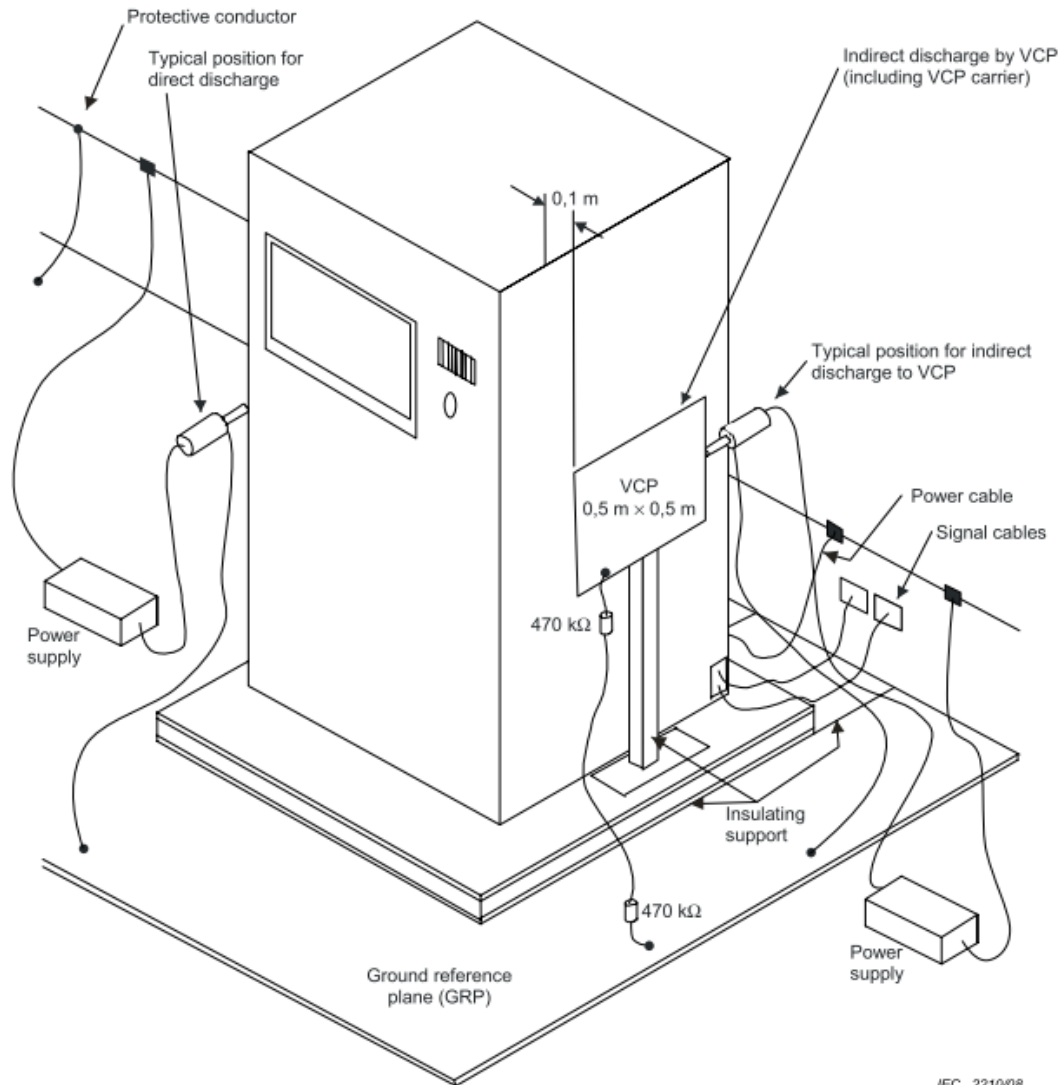

IEC 2210/08



5.3.6 Test Result

Test Voltage	230Vac, 50Hz	Test Date	2024/12/02
Environmental Conditions	21°C, 51% RH	Pressure	1008 mbar
Tested by	Guanwei Liao	Test Site	W01

Test Results of Direct Application

Air Discharge				
Test Point	Discharge Level (kV)			Result
	±2	±4	±8	
Front	NA	NA	NA	NA
Back	A	A	A	A
Left	NA	NA	NA	NA
Right	NA	NA	NA	NA
Top	NA	NA	NA	NA
Bottom	NA	NA	NA	NA
Other	NA	NA	NA	NA

* Test location(s) in which discharge to be applied illustrated by photos shown in next page(s).

Contact Discharge		
Test Point	Discharge Level (kV)	Result
	±4	
Front	B (#1)	B
Back	B (#1)	B
Left	B (#1)	B
Right	B (#1)	B
Top	B (#1)	B
Bottom	B (#1)	B
Other	NA	NA

* Test location(s) in which discharge to be applied illustrated by photos shown in next page(s).

Test Results of Indirect Application

HCP Discharge		
Test Point	Discharge Level (kV)	Result
	±4	
Front	A	A
Back	A	A
Left	A	A
Right	A	A

VCP Discharge		
Test Point	Discharge Level (kV)	Result
	±4	
Front	A	A
Back	A	A
Left	A	A
Right	A	A

Note:

N/A: Not applicable

Criteria A: The EUT function was correct during the test.

Criteria A: (#1) No occur arcing.

Criteria B: (#1) The EUT was interrupted during the test, but could self-recover to the normal mode after the test.

Description of Test Points

Front



Back



*Red Dot - Contact Discharged
Blue Dot - Air Discharged

Left

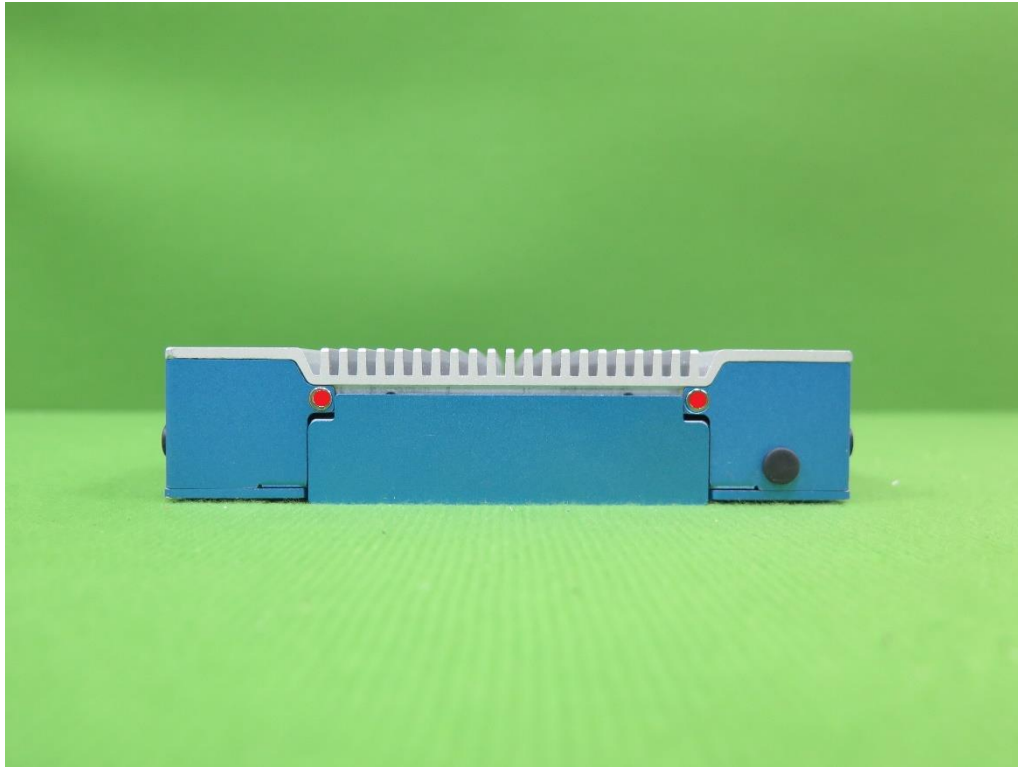

Right

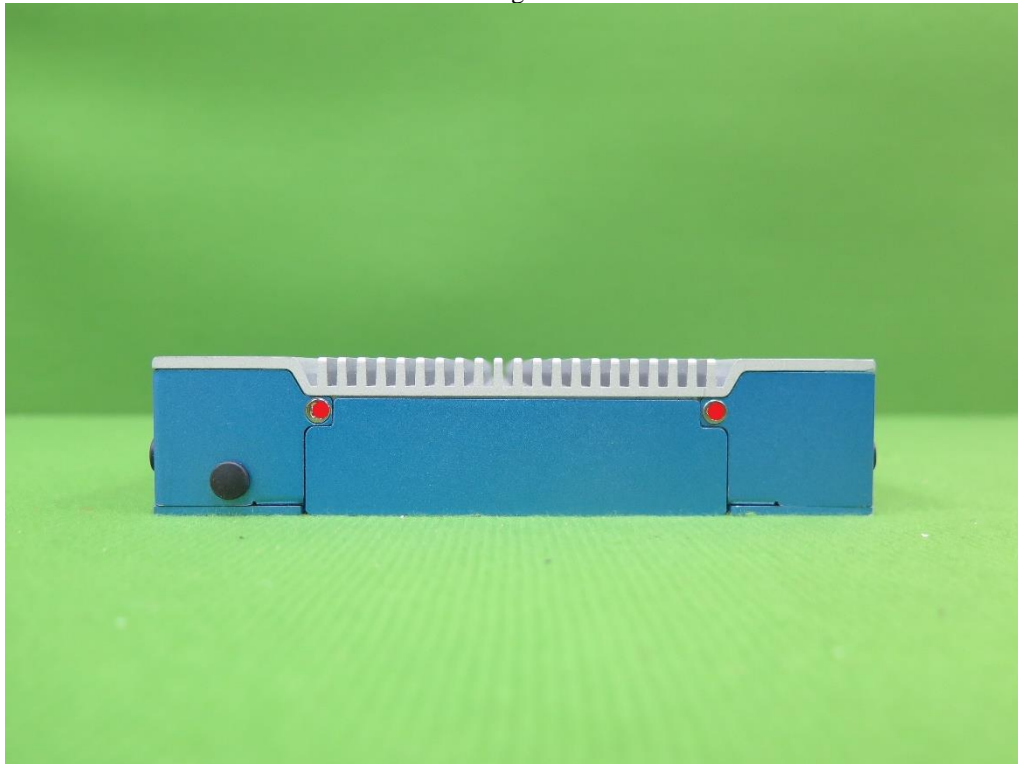

*Red Dot - Contact Discharged
Blue Dot - Air Discharged

Top

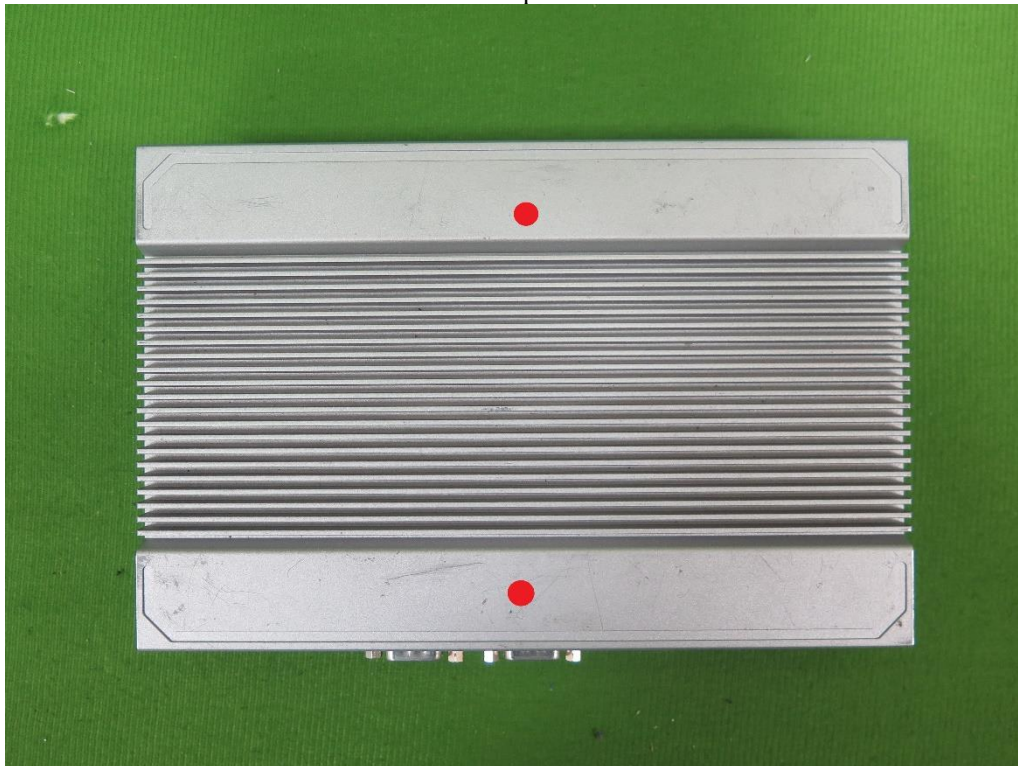

Bottom

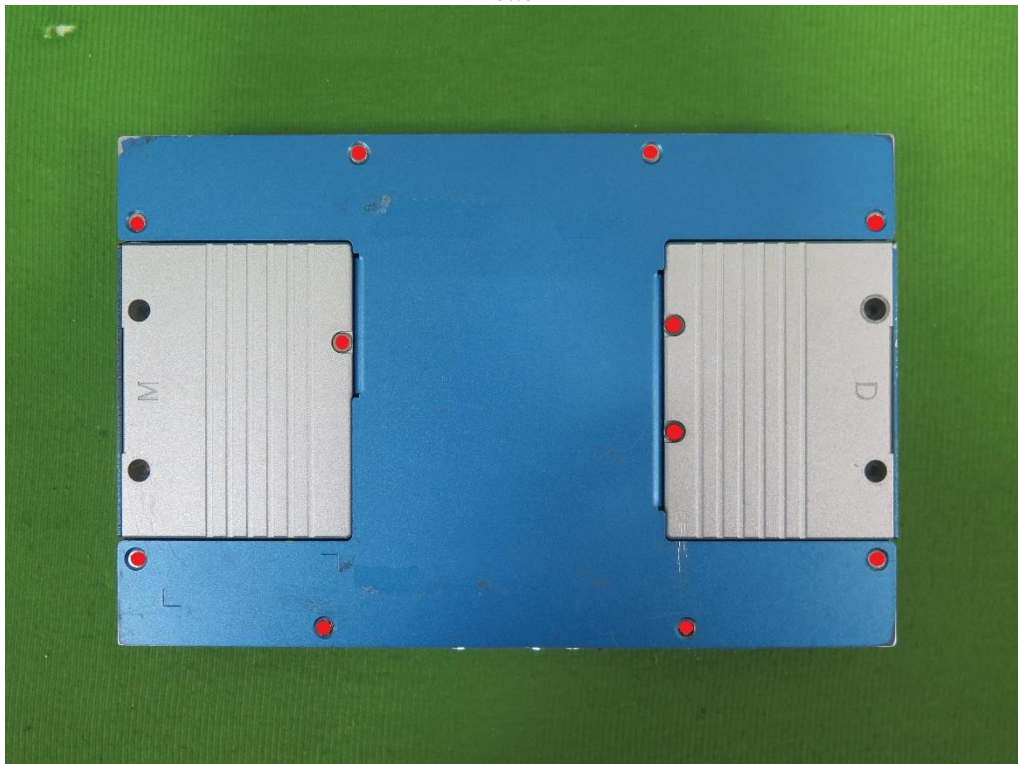

*Red Dot - Contact Discharged
Blue Dot - Air Discharged

5.3.7 Photographs of Test Configuration



5.4 Radiated, Radio-frequency Electromagnetic Field Immunity Test

5.4.1 Test Specification

Standard	IEC/EN 61000-4-3
Frequency Range	80 MHz ~ 1000 MHz, 1800 MHz, 2600 MHz, 3500 MHz, 5000 MHz for spot test
Field Strength	3 V/m
Modulation	80% AM Modulation with 1 kHz Sine Wave
Frequency Step	1%
Polarity of Antenna	Horizontal and Vertical
Test Distance	2.15 m (80 MHz ~ 1000 MHz) 1 m (1 GHz ~ 6 GHz)
Antenna Height	1.55 m (80 MHz ~ 1000 MHz) 1.05 m (1 GHz ~ 6 GHz)
Dwell Time	3 seconds or not exceed 5 seconds

5.4.2 Test Instrument

Item	Equipment	Manufacturer	Model	Meter No.	Calibration Date
1	RadiCentre ® Modular EMC Test Systems	DARE	CTR1004B	CT-1-080	No calibration request
2	RF Signal Generator	DARE	RGN6000B	CT-1-080	Aug. 06, 2024
3	LINEAR POWER RF AMPLIFIER	TESEQ	CBA1G-300 D	CT-1-163	Aug. 06, 2024
4	LINEAR POWER RF AMPLIFIER	OPHIR	5193	CT-1-083	Aug. 06, 2024
5	LINEAR POWER RF AMPLIFIER	FRANKONIA	FLG-30C	CT-1-061	Aug. 06, 2024
6	Periodic Test-Antenna	Schwarzbeck Mess - Elektronik	STLP 9128 E	CT-1-085	No calibration request
7	Stacked Microwave Log.-Per. Antenna	Schwarzbeck Mess - Elektronik	STLP 9149	CT-1-086	No calibration request
8	Electric Field Probe	FRANKONIA	EFS-10	CT-1-060a1	Sep. 29, 2024
9	Measurement Software	EMC-RS	Ver: 2.0.1.3	N/A	No calibration request
10	Conditioning Amplifier / Microphone	B & K	2690-OS2 / 4192-L-001	CT-1-157	May 29, 2024
11	Sound Level Calibrator	B & K	4231	CT-1-156	May 29, 2024
12	Sound Analyer	VGT	ABT CB0	CT-1-159	May 28, 2024
13	Frequency Counter	HEWLETT PACKARD	53181A	CT-1-158	May 25, 2024
14	Audio output Measurement Software	VGT	V1.2-WD	N/A	No calibration request

Note: 1. The calibration interval of the above test instruments is 12 months.

5.4.3 Test Procedure

The test procedure was in accordance with IEC 61000-4-3.

- a. The table-top equipment under test and load, which are placed on a table that is 0.8 meter above ground, are placed with one coincident with the Uniform Field Area (UFA) such that the distance from antenna to the EUT was 2.15 meter at test frequency 80M ~ 1GHz & 1 meter at test frequency 1G ~ 6GHz. Both horizontal and vertical polarization of the antenna and four sides of the equipment under test are set on measurement. All cables shall be connected to the equipment under test and arranged on the test site in accordance with the installation instructions and shall replicate typical installations and use as much as possible.
- b. The specified wiring types and connectors shall be used. If the wiring to and from the equipment under test is not specified, unshielded parallel conductors shall be used. If the product specification require a wiring length of less than or equal to 1 m, then the specified length shall be used. If the length specified is greater than 1 m, or is not specified, then the length of cable used shall be chosen in accordance with typical installation practices. Unless otherwise specified above, a minimum of 1 m of cable shall be exposed to the electromagnetic field in one orientation, either vertical or horizontal.
- c. Each cable does not need to be exposed to the field during the exposure of each face of the equipment under test. But each cable shall, at least during one of the equipment under test orientations, be positioned within the Uniform Field Area (UFA), and thus exposed to the field.
- d. If a product committee determines excess cable length needs to be decoupled (for cables leaving the test area), then the decoupling method used shall not impair the operation of the equipment under test. If cable decoupling is performed, CMADs may be used. The CMAD shall always be placed flat on the floor. Each cable to be decoupled should be treated with a separate CMAD.
- e. If the equipment under test is too large such that it cannot be fully illuminated by the radiating antenna, or exceeds the size of the Uniform Field Area (UFA) then partial illumination shall be used. The equipment under test can be repositioned so that the front surface remains within the Uniform Field Area (UFA) in order to illuminate those sections of the equipment under test that were previously outside the Uniform Field Area (UFA).
- f. The frequency range shall be swept, with the signal 80% amplitude modulated with a 1kHz sine wave. If multiple test signals were used during testing, care should be taken to ensure that any recorded performance degradation was caused by a single test signal and was not caused by the combination of multiple test signals.

5.4.4 Deviation from Standard

No deviation

5.4.5 Test Configuration

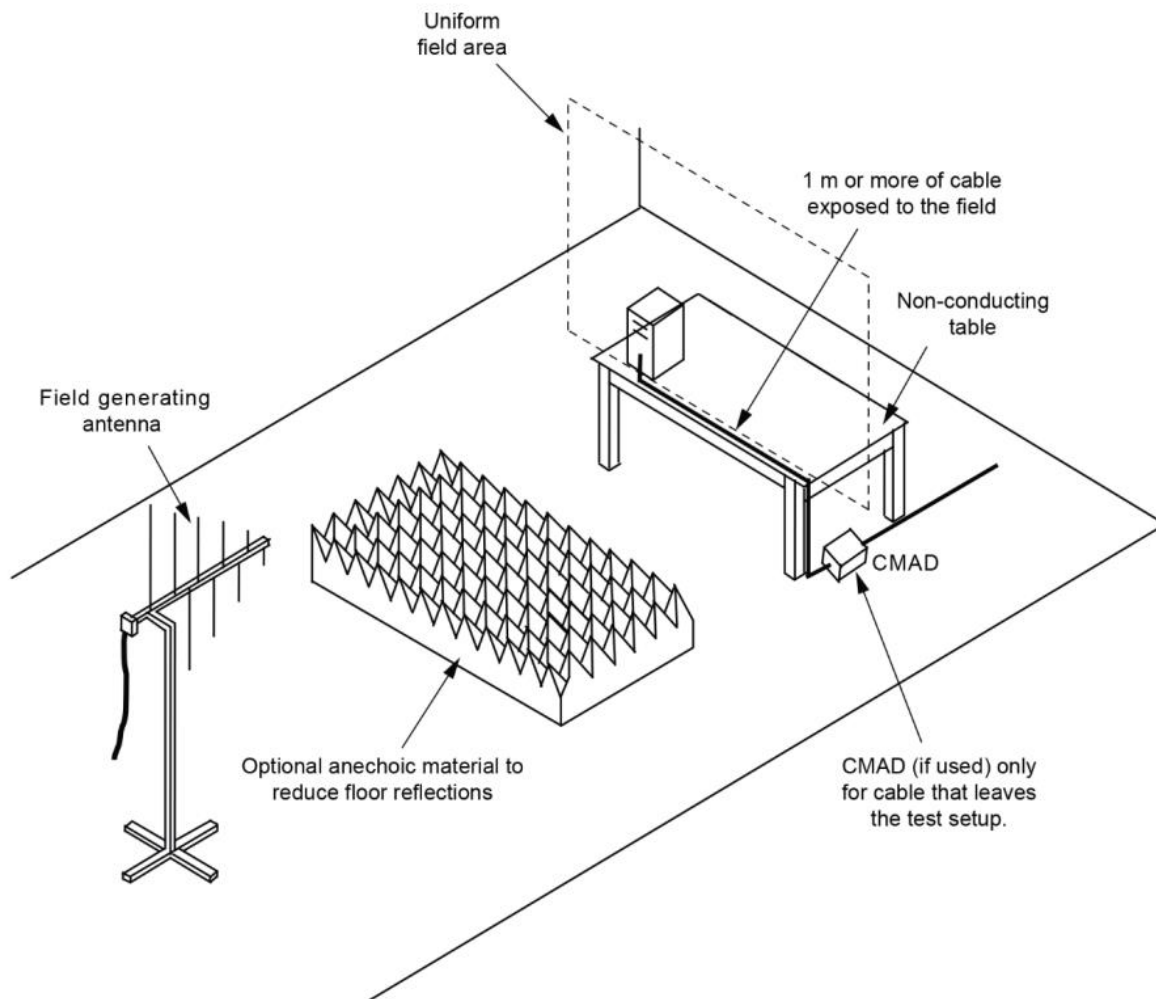



5.4.6 Test Result

Test Voltage	230Vac, 50Hz	Environmental Conditions	22°C, 50% RH
Tested by	Alan Chung	Test Date	2024/11/22

Frequency Range (MHz)	Azimuth	Polarity	Field Strength (V/m)	Modulation	Result
80 ~ 1000	0, 90, 180, 270	H/V	3	80% AM (1kHz)	A
1800	0, 90, 180, 270	H/V	3	80% AM (1kHz)	A
2600	0, 90, 180, 270	H/V	3	80% AM (1kHz)	A
3500	0, 90, 180, 270	H/V	3	80% AM (1kHz)	A
5000	0, 90, 180, 270	H/V	3	80% AM (1kHz)	A

Note:

Criteria A: The EUT function was correct during the test.

Not supporting telephony audio output function acoustic/electrical measurements

Frequency Range (MHz)	Azimuth	Polarity	Field Strength (V/m)	Modulation	Result
80 ~ 1000	0, 90, 180, 270	H/V	3	80% AM (1kHz)	A
1800	0, 90, 180, 270	H/V	3	80% AM (1kHz)	A
2600	0, 90, 180, 270	H/V	3	80% AM (1kHz)	A
3500	0, 90, 180, 270	H/V	3	80% AM (1kHz)	A
5000	0, 90, 180, 270	H/V	3	80% AM (1kHz)	A

Note:

Criteria A: The audio output performance evaluation criteria were satisfied. The interference ratio is -20 dB or better.

5.4.7 Photographs of Test Configuration



5.5 Electrical Fast Transient / Burst Immunity Test

5.5.1 Test Specification

Standard	IEC/EN 61000-4-4
Test Voltage	AC Main Power Port: ± 1 kV DC Network Power Port ^(Note 1) (cable length > 3m): ± 0.5 kV Analogue/Digital Data Ports ^(Note 1) (cable length > 3m): ± 0.5 kV
Polarity	Positive & Negative
Impulse Frequency	CPE xDSL Ports: 100 kHz Other: 5 kHz
Impulse Wave	5/50 ns
Burst Duration	15 ms
Burst Period	300 ms
Test Duration	Not less than 1 min.

Note: 1. Applicable only to port which, according to the manufacturer's specification, support cabled lengths greater than 3m.

5.5.2 Test Instrument

Item	Equipment	Manufacturer	Model	Meter No.	Calibration Date
1	EFT Generator	3ctest	EFT500S	CT-1-165	Sep. 27, 2024
2	Clamp	3ctest	CCC100	CT-1-166	Sep. 27, 2024

Note: 1. The calibration interval of the above test instruments is 12 months.

5.5.3 Test Procedure

The test procedure was in accordance with IEC 61000-4-4.

- a. The table-top equipment under test was placed on a table that is 0.8 meter height. A ground reference plane is placed on the table, and uses 0.1 m insulation between the equipment under test and ground reference plane. The floor-standing equipment under test was placed on 0.1 m insulation support unit between the equipment under test and ground reference plane.
- b. The minimum area of the ground reference plane is 1 m × 1 m, and 0.65 mm thick min, and projected beyond the equipment under test by at least 0.1 m on all sides. The equipment under test shall be arranged and connected to satisfy its functional requirements, according to the equipment installation specifications.

For input power ports:

The equipment under test is connected to the power ports through a coupling device that directly couples the EFT/B interference signal. Each of the line conductors is impressed with burst noise for 1 minute. The distance between the coupling device and the table-top equipment under test is 0.5 m.

For signal / data ports:

The capacitive coupling clamp shall be used for the application of the test voltages. The test voltages shall be coupled to all of the equipment under test ports in turn including those between two units of equipment involved in the test, unless the length of the interconnecting cable makes it impossible to test.

5.5.4 Deviation from Standard

No deviation

5.5.5 Test Configuration

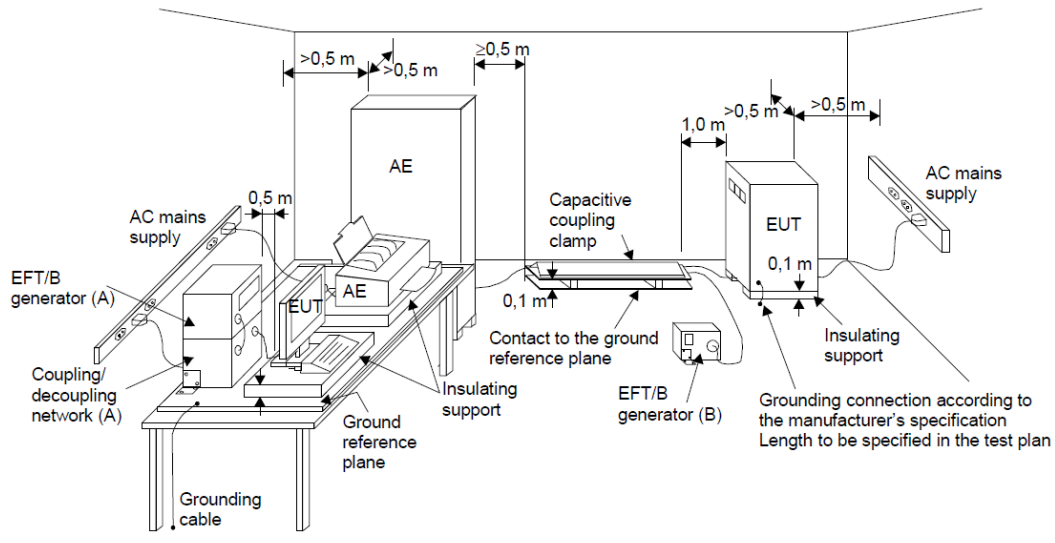

- (A) location for supply line coupling
- (B) location for signal lines coupling

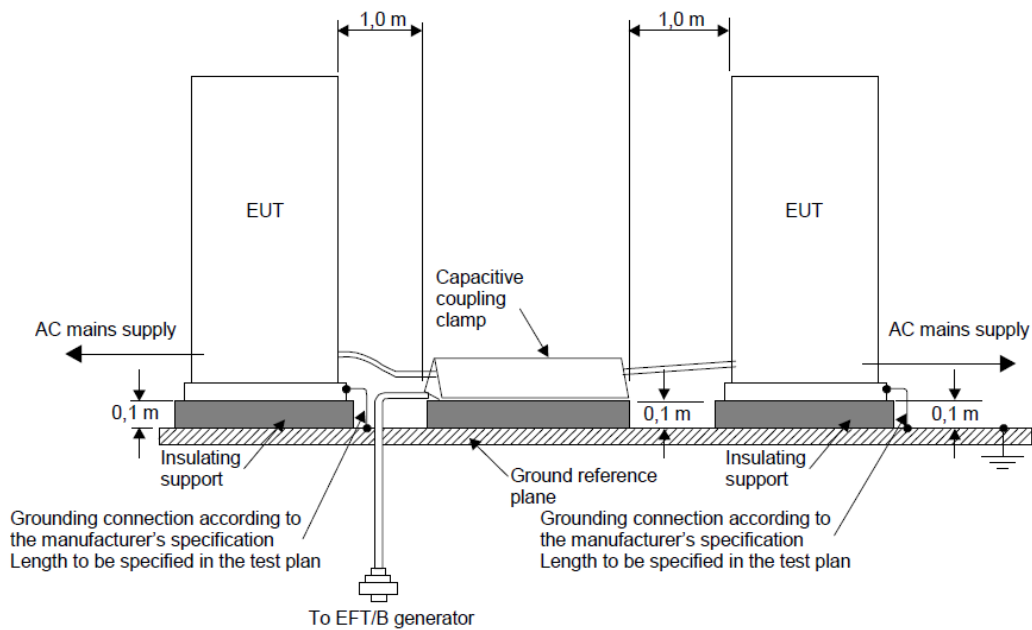



5.5.6 Test Result

Test Voltage	230Vac, 50Hz	Environmental Conditions	25°C, 54% RH
Tested by	Eric Hsieh	Test Date	2024/10/21

Test Point		Test Level (kV)	Polarity (+/-)	Result
AC Power Port	L	1	+/-	A
	N	1	+/-	A
	PE	1	+/-	A
	L + N	1	+/-	A
	L + PE	1	+/-	A
	N + PE	1	+/-	A
	L + N + PE	1	+/-	A
Signal Ports Telecommunication Ports	LAN	0.5	+/-	A

Note:

Criteria A: The EUT function was correct during the test.

5.5.7 Photographs of Test Configuration

Power



Signal



5.6 Surge Immunity Test

5.6.1 Test Specification

Standard	IEC/EN 61000-4-5
Wave- Shape	AC Main Power Port: 1.2/50 μ s Open Circuit Voltage, 8/20 μ s Short Circuit Current DC Network Power Port ^(Note 1) : 1.2/50 μ s Open Circuit Voltage, 8/20 μ s Short Circuit Current Analogue/Digital Data Ports (unshielded symmetrical) (Direct to outdoor cables ^(Note 2, 3)): 10/700 μ s Open Circuit Voltage, 5/320 μ s Short Circuit Current Analogue/Digital Data Ports (coaxial or shielded) (Direct to outdoor cables ^(Note 2, 3)): 1.2/50 μ s Open Circuit Voltage, 8/20 μ s Short Circuit Current
Test Voltage	AC Main Power Port - Line to Line: ± 1 kV, Line to Ground: ± 2 kV DC Network Power Port (cable length > 3m) - Line to Ground: ± 0.5 kV Analogue/Digital Data Port (unshielded symmetrical): Line to Ground Apply where primary protection is intended: ± 1 kV and ± 4 kV Apply where primary protection is not intended: ± 1 kV Analogue/Digital Data Ports (coaxial or shielded) - Shielded to Ground: ± 0.5 kV
Polarity	Positive/Negative
Phase Angle	0°/90°/180°/270° (For AC Main Power Port)
Pulse Repetition Rate	1 time / min. (maximum)
Times	5 Positive and 5 Negative at selected points

- Note:**
1. Applicable only to port which, according to the manufacturer's specification, support cabled lengths greater than 3 m.
 2. Surges are applied with primary protection fitted. Where possible, use the actual primary protector intended to be use in the installation. Where the surge coupling network for the 10/700 (5/320) μ s wave affects the functioning of high speed data ports, the test shall be carried out using 1.2/50 (8/20) μ s wave and appropriate coupling network.
 3. Surges are applicable to ports which satisfy all the following conditions:
 May connect directly to cables that leave the building structure.
 Defined as an antenna port, a wired network, or a broadcast receiver tuner port.
 Typical port covered include xDSL, PSTN, CATV, antenna and similar. Exclude ports are LAN and similar.

5.6.2 Test Instrument

Item	Equipment	Manufacturer	Model	Meter No.	Calibration Date
1	Surge Generator	HAEFELY	AXOS8	CT-1-059(1)	Aug. 12, 2024
2	Surge CDN	3cTest	CDN-405T8A1	CT-1-074(5)	May 27, 2024

Note: 1. The calibration interval of the above test instruments is 12 months.

5.6.3 Test Procedure

The test procedure was in accordance with IEC 61000-4-5.

- a. The table-top equipment under test was placed on a table that is 0.8 meter height. A ground reference plane is placed on the table, and uses 0.1m insulation between the equipment under test and ground reference plane.
- b. If not otherwise specified the power cord between the EUT and the coupling network shall not exceed 2 m in length.

For input power ports:

The table-top equipment under test was connected to the power ports through a coupling device that directly couples the surge interference signal. The surge noise shall be applied synchronized to the peak value of the voltage wave (Positive and negative). Each of Line to Earth and Line to Line is impressed with a sequence of five surge voltages with interval of 1 minute.

For signal / data ports:

The table-top equipment under test was connected to the signal ports of associated equipment through a Coupling / De-coupling Network (CDN). The surge noise shall be applied synchronized to the peak value of the voltage wave (Positive and negative). Each of Line to Earth is impressed with a sequence of five surge voltages with interval of 1 minute.

For shielded lines:

The table-top equipment under test is isolated from ground and the surge is applied to its metallic enclosure; the termination (or auxiliary equipment) at the port under test is grounded. The length of the cable between the port under test and the device attached to the other end of the cable shall be 20 m (preferred length) or, the shortest length over 10 m, where the manufacturer provides pre-assembled cables used in actual installations. For EUTs which do not have metallic enclosures, the surge is applied directly to the shielded cable at the EUT side.

No test shall be required for cables which according to the manufacturer's specification are ≤ 10 m.

5.6.4 Deviation from Standard

No deviation

5.6.5 Test Configuration

< Table-Top equipment under test >

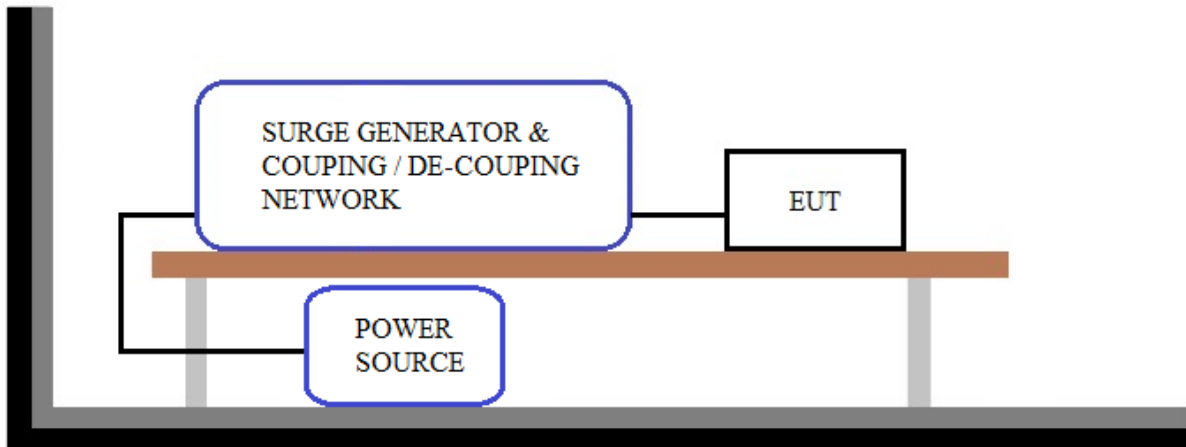

< Floor-Standing equipment under test >

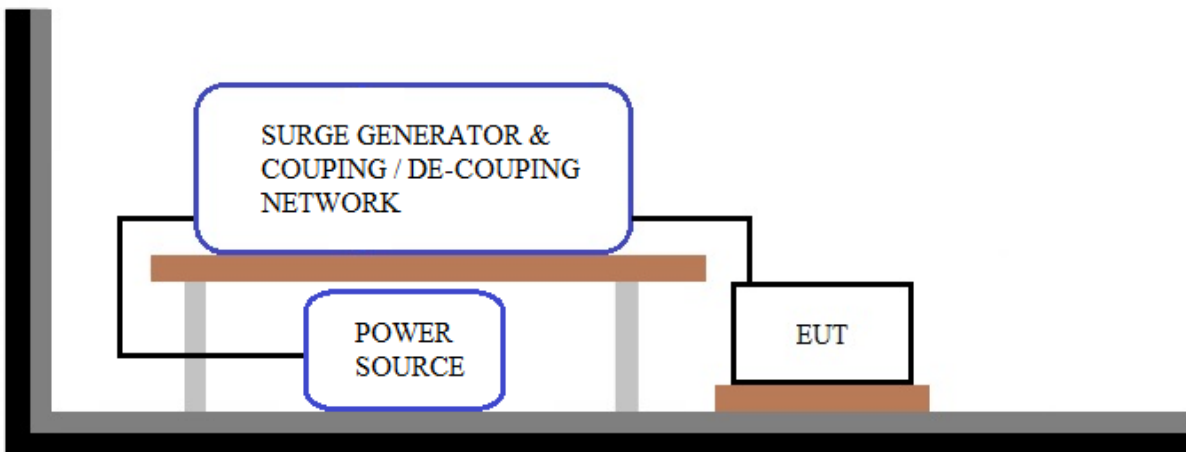



5.6.6 Test Result

Test Voltage	230Vac, 50Hz	Environmental Conditions	22°C, 51% RH
Tested by	Guanwei Liao	Test Date	2024/12/02
Test Site	W01		

AC Power Port						
Test Point	Phase	Polarity (+/-)	Test Voltage (kV)			Result
			0.5	1	2	
L to N	0°	+/-	A	A	-	A
	90°	+/-	A	A	-	
	180°	+/-	A	A	-	
	270°	+/-	A	A	-	
L to PE	0°	+/-	A	A	A	A
	90°	+/-	A	A	A	
	180°	+/-	A	A	A	
	270°	+/-	A	A	A	
N to PE	0°	+/-	A	A	A	A
	90°	+/-	A	A	A	
	180°	+/-	A	A	A	
	270°	+/-	A	A	A	

Note:

Criteria A: The EUT function was correct during the test.

5.6.7 Photographs of Test Configuration

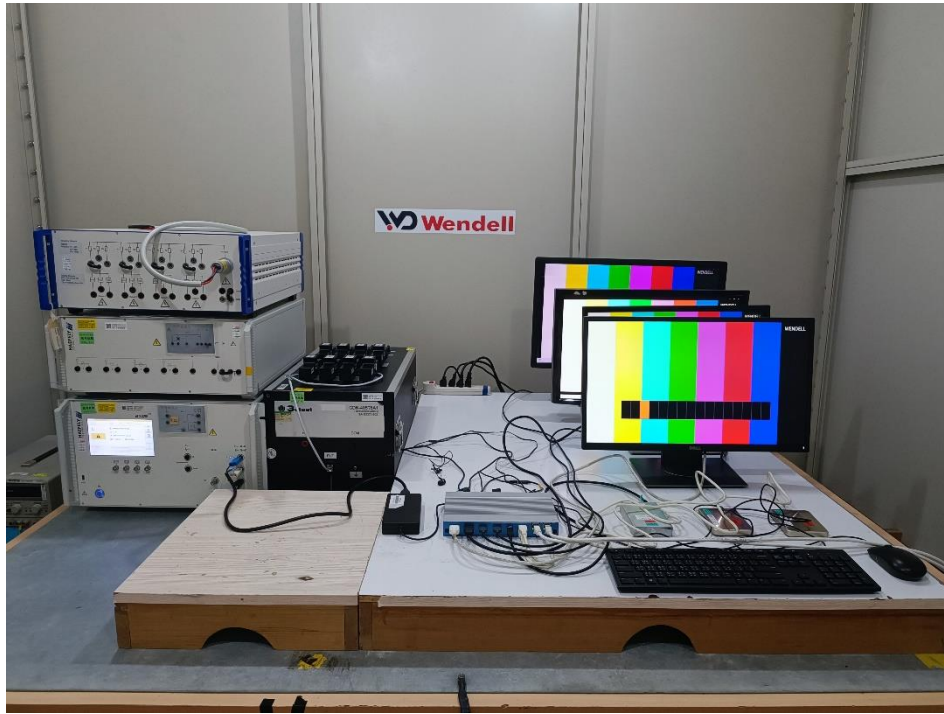



5.7 Conducted Disturbances Immunity Test

5.7.1 Test Specification

Standard	IEC/EN 61000-4-6
Frequency Range	0.15 ~ 10 MHz, 10 ~ 30 MHz, 30 ~ 80 MHz
Voltage Level	3 V, 3 - 1 V, 1 V
Modulation	80% AM Modulation with 1 kHz Sine Wave
Frequency Step	1%
Dwell Time	3 seconds

5.7.2 Test Instrument

Item	Equipment	Manufacturer	Model	Meter No.	Calibration Date
1	Coupling clamp according to IEC 6100-4-6	FRANKONIA	EMCL-20	CT-1-049	May 30, 2024
2	CDN for power supply lines	FRANKONIA	CDN M2+M3	CT-1-054	May 30, 2024
3	6 dB Attenuator	BIRD	75-A-FFN-06	CT-1-056	May 30, 2024
4	Compact Immunity Test System acc	FRANKONIA	CIT-10/75	CT-1-057	May 30, 2024
5	CDN for screened lines	FRANKONIA	RJ45S	CT-1-052 (1)	May 30, 2024
6	50ohm Termination	N/A	N/A	CT-1-065-1	May 30, 2024
7	CDN Four Balanced Pairs-unscreened	Com-Power	CDN-T8E	CT-1-130	May 30, 2024
8	Measurement Software	HUBERT	Ver: 1.1.2	N/A	No calibration request
9	Conditioning Amplifier / Microphone	B & K	2690-OS2 / 4192-L-001	CT-1-157	May 29, 2024
10	Sound Level Calibrator	B & K	4231	CT-1-156	May 29, 2024
11	Sound Analyer	VGT	ABT CB0	CT-1-159	May 28, 2024
12	Frequency Counter	HEWLETT PACKARD	53181A	CT-1-158	May 25, 2024
13	Audio output Measurement Software	VGT	V1.2-WD	N/A	No calibration request

Note: 1. The calibration interval of the above test instruments is 12 months.

5.7.3 Test Procedure

The test procedure was in accordance with IEC 61000-4-6.

- a. The table-top equipment under test was placed on an insulating support of 0.1 m height above a reference ground plane. If the equipment is designed to be mounted in a panel, rack or cabinet, then it shall be tested in this configuration. Grounding of the equipment shall be consistent with the EUT's installation instructions. The Coupling/De-coupling Network (CDN) shall be located between 0.1 m and 0.3 m from the equipment under test.
- b. The frequency range shall be swept, using the signal level established during the setting process and with a disturbance signal of 80 % amplitude. The signal is modulated with a 1 kHz sine wave, pausing to adjust the RF signal level or the switch coupling devices as necessary. Where the frequency is swept incrementally, the step size shall not exceed 1 % of the preceding frequency value.

For input power ports:

The table-top equipment under test was connected to the power ports through a Coupling/De-coupling Network (CDN) for power supply lines. And directly couples the disturbances signal into equipment under test.

For signal / data ports:

The table-top equipment under test was connected to the signal ports of associated equipment through a Coupling/De-coupling Network (CDN). And directly couples the disturbances signal into equipment under test.

5.7.4 Deviation from Standard

No deviation

5.7.5 Test Configuration

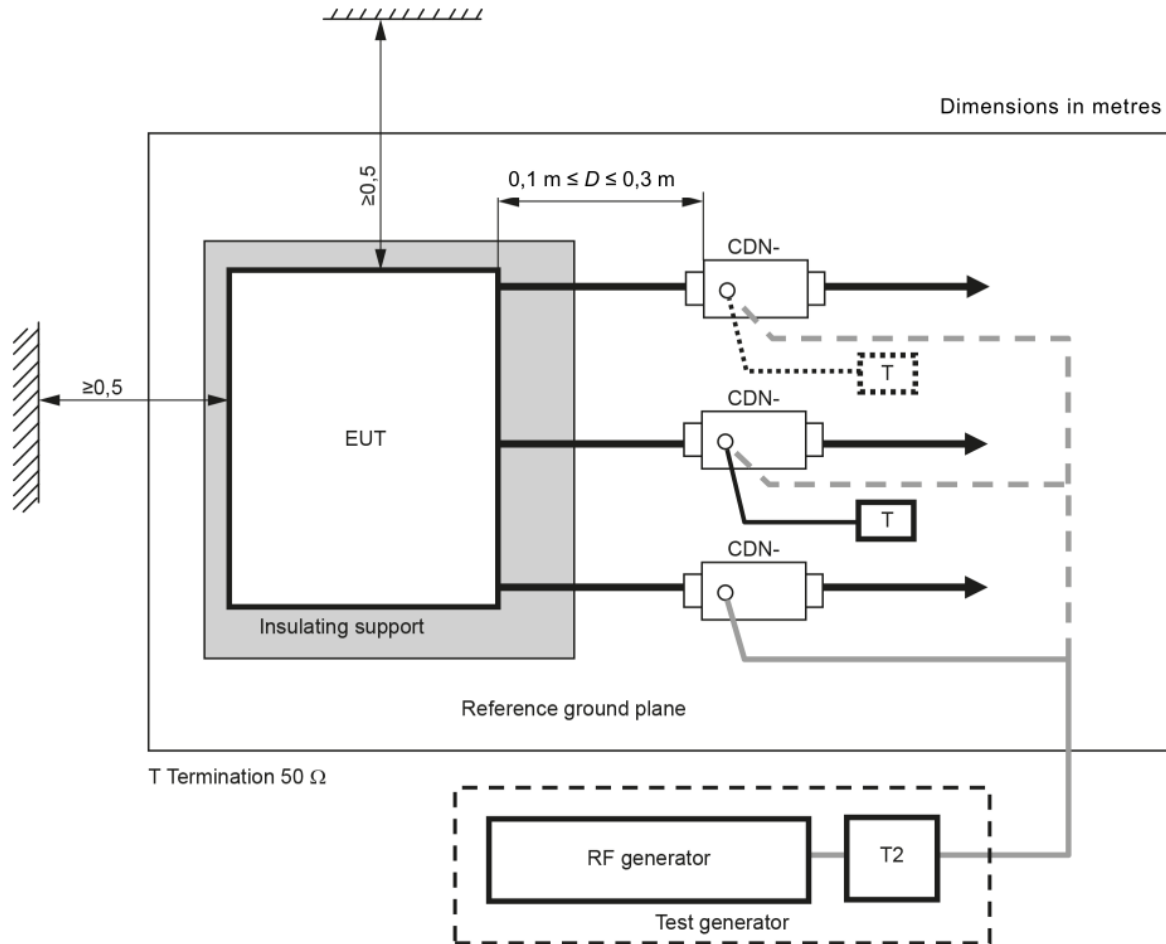

Note:

1. The EUT clearance from any metallic objects other than test equipment shall be at least 0,5 m.
2. Only one of the CDNs not used for injection shall be terminated with 50 Ω, providing only a single return path.
All other CDNs shall be configured as decoupling networks.



5.7.6 Test Result

Test Voltage	230Vac, 50Hz	Environmental Conditions	25°C, 54% RH
Tested by	Eric Hsieh	Test Date	2024/10/23

Frequency Range (MHz)	Tested Port	Injection Method	Test Level (V _{r.m.s.})	Modulation	Result
0.15 ~ 10	AC Power	CDN-M2 +M3 (M3)	3	80% AM, 1kHz	A
10 ~ 30	AC Power	CDN-M2 +M3 (M3)	3 - 1	80% AM, 1kHz	A
30 ~ 80	AC Power	CDN-M2 +M3 (M3)	1	80% AM, 1kHz	A
0.15 ~ 10	LAN	CDN RJ45/S	3	80% AM, 1kHz	A
10 ~ 30	LAN	CDN RJ45/S	3 - 1	80% AM, 1kHz	A
30 ~ 80	LAN	CDN RJ45/S	1	80% AM, 1kHz	A

Note:

Criteria A: The EUT function was correct during the test.

Not supporting telephony audio output function acoustic/electrical measurements

Frequency Range (MHz)	Tested Port	Injection Method	Test Level (V _{r.m.s.})	Modulation	Result
0.15 ~ 10	AC Power	CDN-M2 +M3 (M3)	3	80% AM, 1kHz	A
10 ~ 30	AC Power	CDN-M2 +M3 (M3)	3 - 1	80% AM, 1kHz	A
30 ~ 80	AC Power	CDN-M2 +M3 (M3)	1	80% AM, 1kHz	A

Note:

Criteria A: The audio output performance evaluation criteria were satisfied. The interference ratio is -20 dB or better.

5.7.7 Photographs of Test Configuration

Power

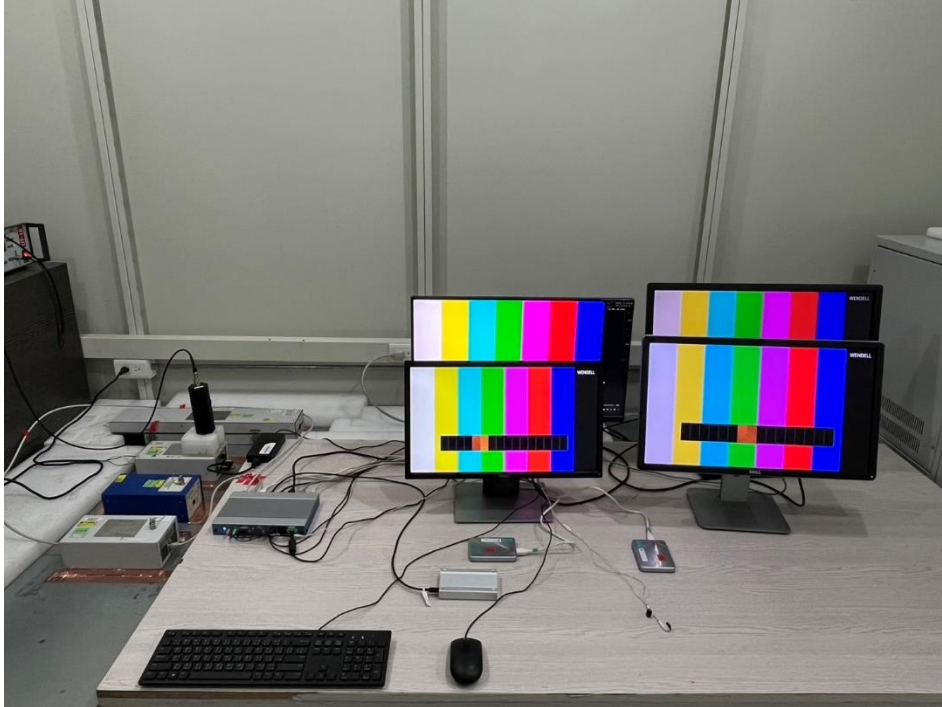

Signal

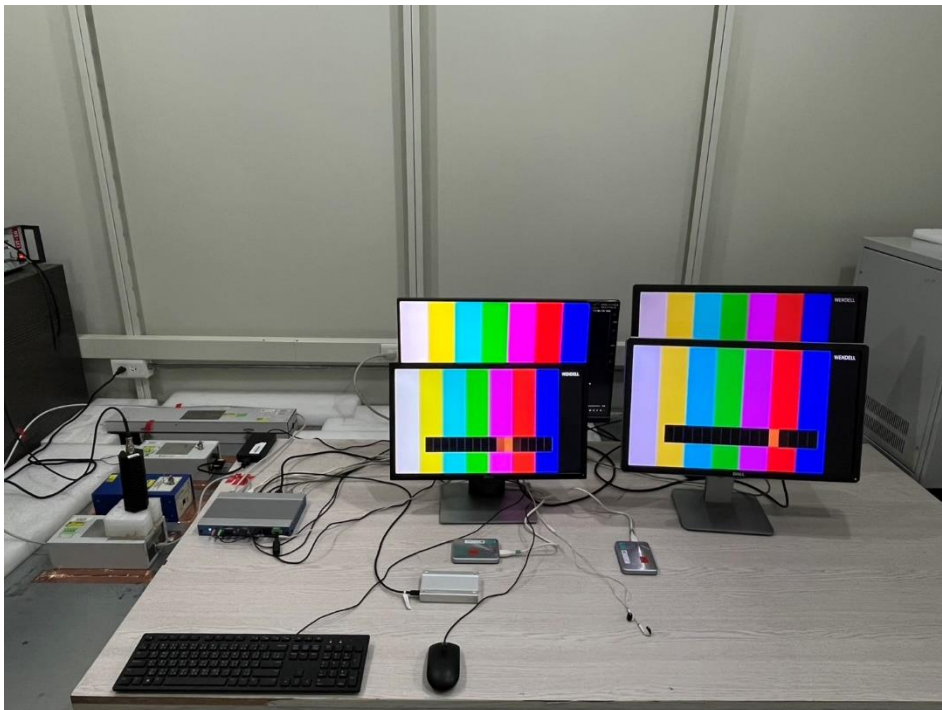

5.8 Power Frequency Magnetic Field Immunity Test

5.8.1 Test Specification

Standard	IEC/EN 61000-4-8
Frequency Range	50/60Hz
Field Strength	1 A/m
Observation Time	1 minute
Inductance Coil	Rectangular type, 1mx1m

Note: 1. Applicable only to equipment containing devices intrinsically susceptible to magnetic field, such as CRT monitors, Hall effect elements, electron-dynamic microphones, magnetic field sensors or audio frequency transformers.

5.8.2 Test Instrument

Item	Equipment	Manufacturer	Model	Meter No.	Calibration Date
1	PFMF	SGH	HMFG1000	CT-1-164	Sep. 28, 2024

Note: 1. The calibration interval of the above test instruments is 24 months.

5.8.3 Test Procedure

The test procedure was in accordance with IEC 61000-4-8.

- a. The table-top equipment under test was placed on a table which is 0.8 meter above a metal ground plane measured at least 1m × 1m minimum. The test magnetic field shall be placed at central of the induction coil. The floor-standing equipment under test was placed on 0.1m insulation support unit between the EUT and ground reference plane.
- b. The test magnetic Field shall be applied 10 minutes by the immersion method to the table-top equipment under test, and the induction coil shall be rotated by 90° in order to expose the equipment under test to the test field with different orientation (X, Y, Z Orientations). The test magnetic Field shall be applied 10 minutes by the proximity method to the floor-standing equipment under test, and the induction coil shall be rotated by 90° in order to expose the equipment under test to the test field with different orientation (X, Y, Z Orientations).

5.8.4 Deviation from Standard

No deviation

5.8.5 Test Configuration

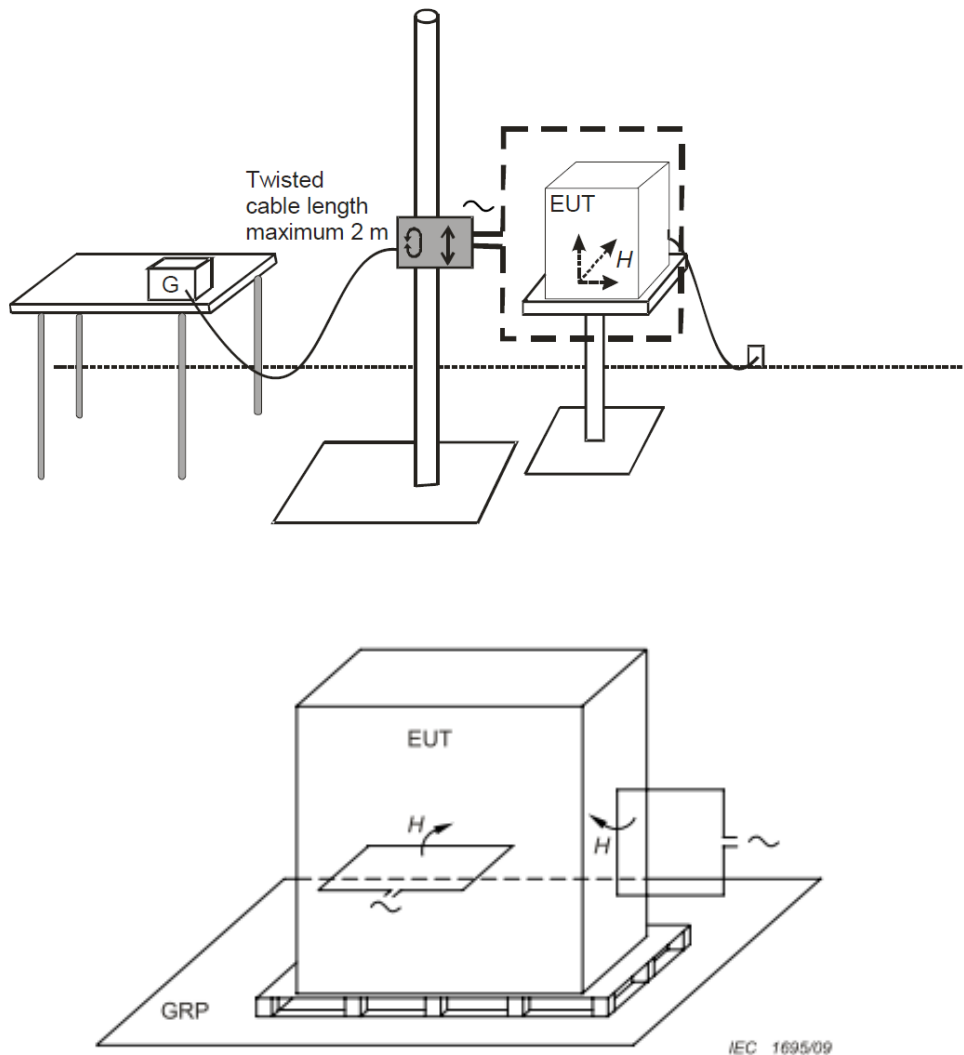

For the actual test configuration, please refer to 5.8.7.

NOTE:

TABLETOP EQUIPMENT

The equipment shall be subjected to the test magnetic field by using the induction coil of standard dimension (1 m x 1 m). The induction coil shall then be rotated by 90 degrees in order to expose the EUT to the test field with different orientations.

FLOOR-STANDING EQUIPMENT

The equipment shall be subjected to the test magnetic field by using induction coils of suitable dimensions. The test shall be repeated by moving and shifting the induction coils, in order to test the whole volume of the EUT for each orthogonal direction. The test shall be repeated with the coil shifted to different positions along the side of the EUT, in steps corresponding to 50 % of the shortest side of the coil. The induction coil shall then be rotated by 90 degrees in order to expose the EUT to the test field with different orientations.



5.8.6 Test Result

Test Voltage	230Vac, 50Hz	Environmental Conditions	21°C, 51% RH
Tested by	Guanwei Liao	Test Date	2024/10/24

Test Coil Position	Frequency (Hz)	Magnetic Strength (A/m)	Result
X - Axis	50/60	1	A
Y - Axis	50/60	1	A
Z - Axis	50/60	1	A

Note:

Criteria A: The EUT function was correct during the test.

5.8.7 Photographs of Test Configuration



5.9 Voltage Dips & Short Interruptions Immunity Test

5.9.1 Test Specification

Basic Standard	IEC/EN 61000-4-11
Test Level	Voltage Dips: >95% reduction, 0.5 cycle 30% reduction, 25 cycle Voltage Interruptions: >95% reduction, 250 cycle
Test Duration Time	Minimum 3 test events in sequence
Interval between Event	Minimum 10 seconds
Phase Angle	0° / 180°
Test Cycle	3 times

Note: 1. Changes to occur at 0 degree crossover point of the voltage waveform. If the EUT does not demonstrate compliance when tested with 0 degree switching, the test shall be repeated with the switching occurring at both 90 degrees and 270 degrees. If the EUT satisfies these alternative requirements, then it fulfils the requirements. This condition shall be recorded in the test report.

5.9.2 Test Instrument

Item	Equipment	Manufacturer	Model	Meter No.	Calibration Date
1	DIP Simulator	3ctest	PFS2216S	CT-1-167	Sep. 27, 2024

Note: 1. The calibration interval of the above test instruments is 12 months.

5.9.3 Test Procedure

The test procedure was in accordance with IEC 61000-4-11.

- a. The test shall be performed with the equipment under test connected to the test generator with the shortest power supply cable as specified by the equipment under test manufacturer. If no cable length is specified, it shall be the shortest possible length suitable to the application of the equipment under test. For equipment under test with more than one power cord, each power cord should be tested individually.
- b. The equipment under test shall be tested for each selected combination of test levels and duration with a sequence of 3 dips/interruptions with intervals of 10 s minimum (between each test event). Each representative mode of operation shall be tested. Abrupt changes in supply voltage shall occur at 0 voltage crossover point of the voltage waveform.
- c. For each test, any degradation of performance shall be recorded. The monitoring equipment should be capable of displaying the status of the operational mode of the equipment under test during and after the tests. After each group of tests, a full functional check shall be performed.

5.9.4 Deviation from Standard

No deviation

5.9.5 Test Configuration

< Table-Top equipment under test >

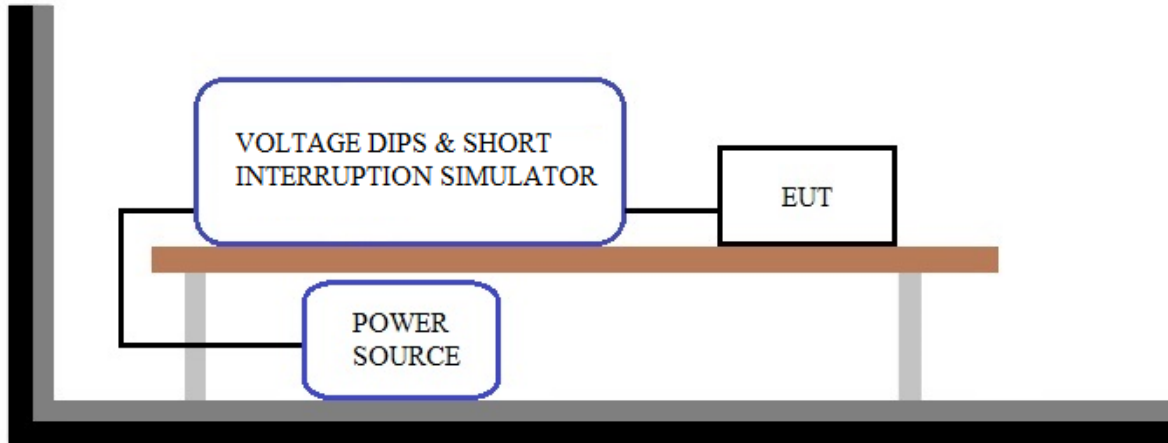

< Floor-Standing equipment under test >

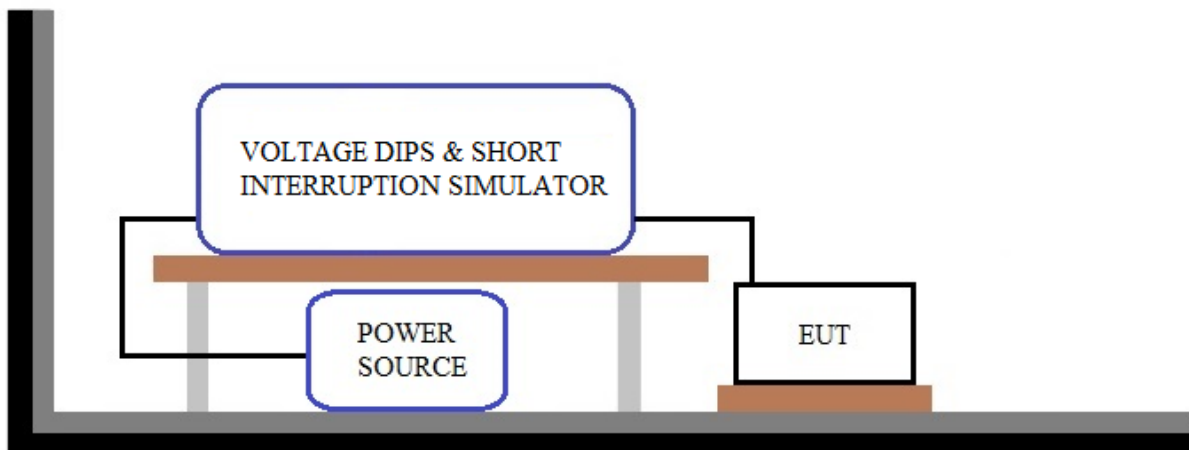



5.9.6 Test Result

Test Voltage	100-240Vac, 50Hz	Environmental Conditions	25°C, 55% RH
Tested by	Eric Hsieh	Test Date	2024/10/21

230Vac, 50Hz			
Test Item	% Reduction	Duration (Period)	Result
Voltage Dips	>95	0.5	A
	30	25	A
Voltage interruptions	>95	250	C (#1)

240Vac, 50Hz			
Test Item	% Reduction	Duration (Period)	Result
Voltage Dips	>95	0.5	A
	30	25	A
Voltage interruptions	>95	250	C (#1)

100Vac, 50Hz			
Test Item	% Reduction	Duration (Period)	Result
Voltage Dips	>95	0.5	A
	30	25	A
Voltage interruptions	>95	250	C (#1)

Note:

Criteria A: The EUT function was correct during the test.

Criteria C: (#1) The EUT was shut down during the test, and must be recovered manually.

5.9.7 Photographs of Test Configuration



< End Page >